

Мир вокруг МЕНЯ

(часть 2)

***Знакомим детей
с окружающим миром,
предметами и явлениями,
которые нас окружают***

Назови предметы одним словом.

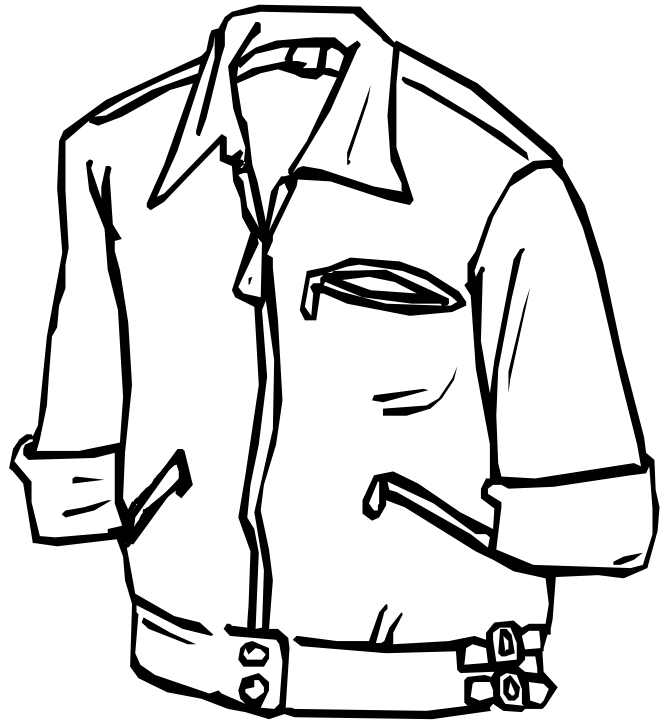

Назови детали одежды.



Из чего сделана эта одежда?

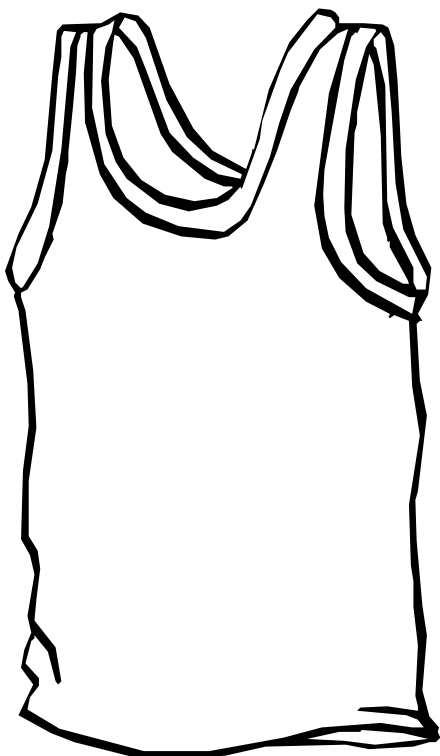

Что можно одеть зимой, а что летом?

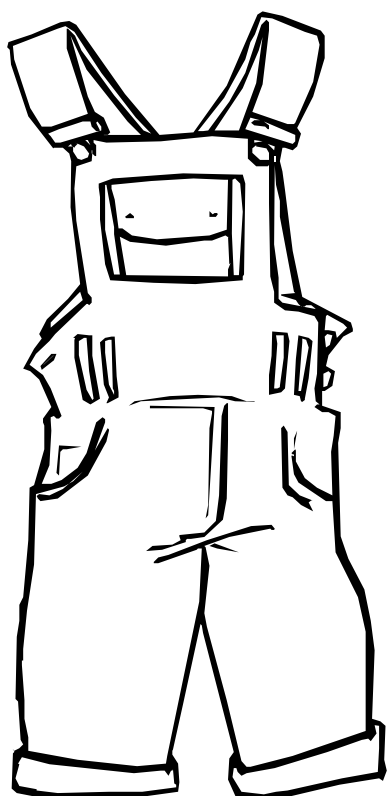

Какая одежда мужская, женская, общая?

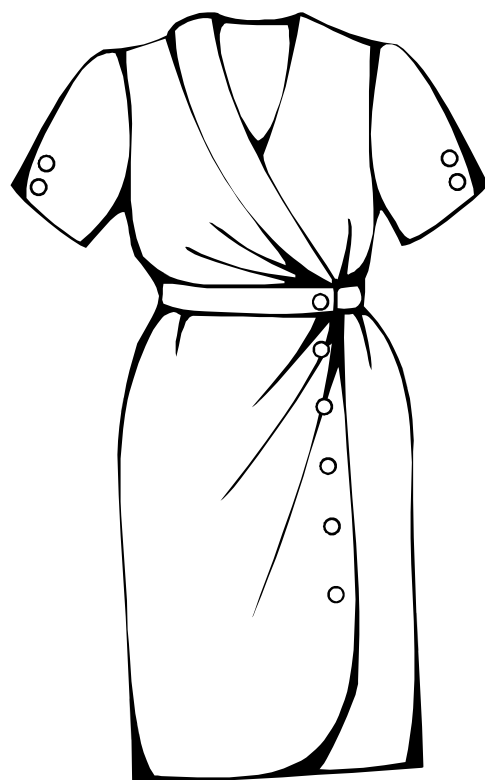
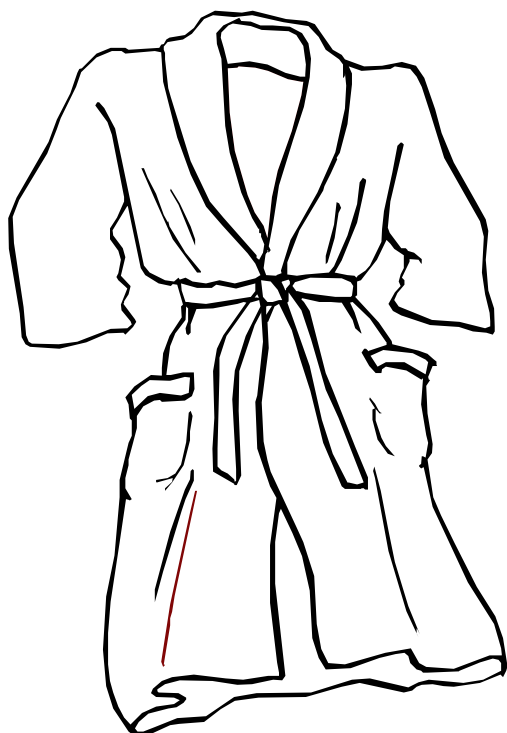
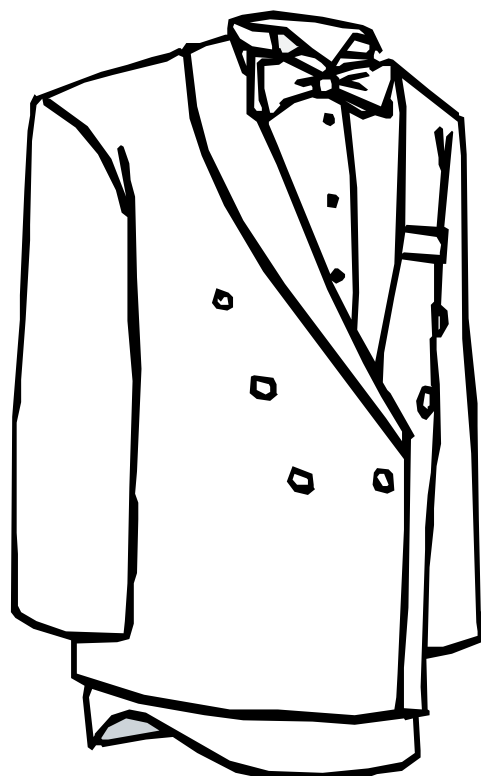
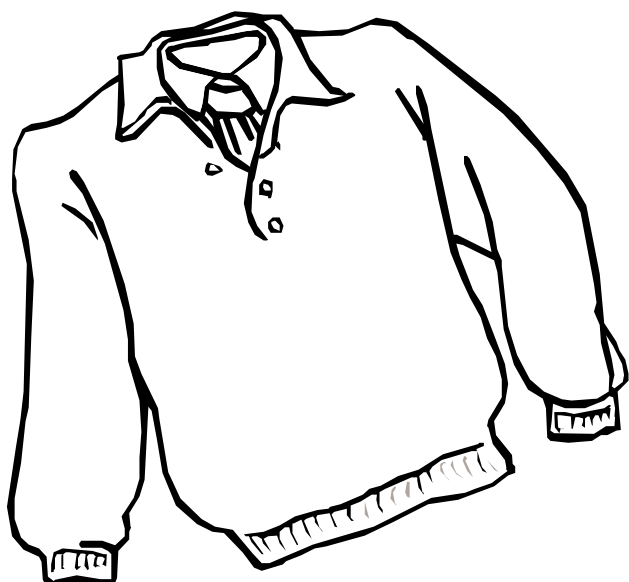

Когда одевают такую обувь?

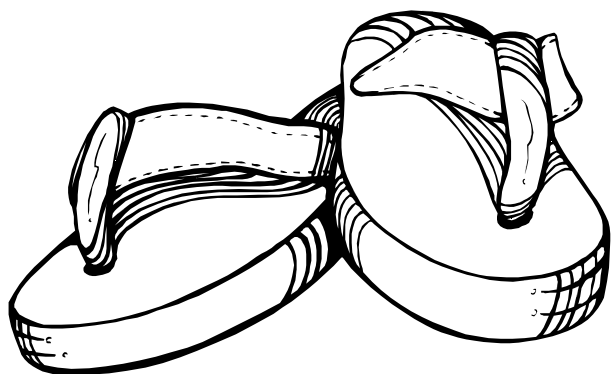
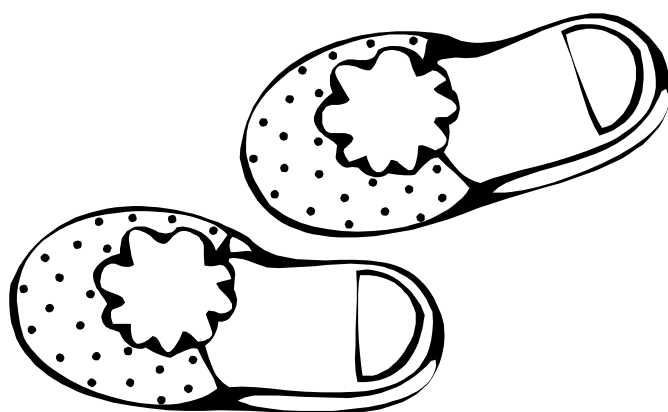
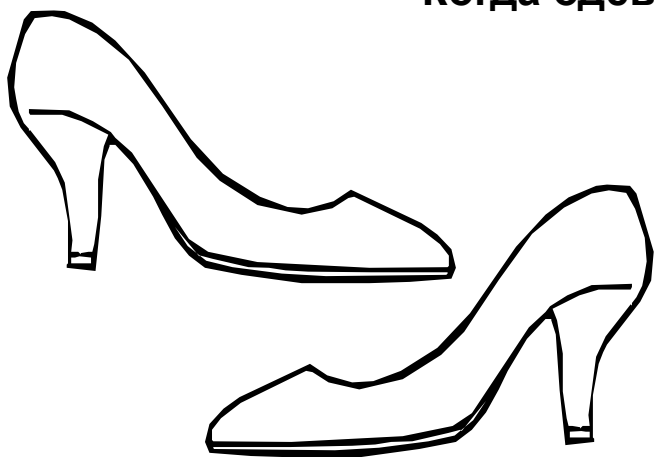

Кто и когда носит такие головные уборы?

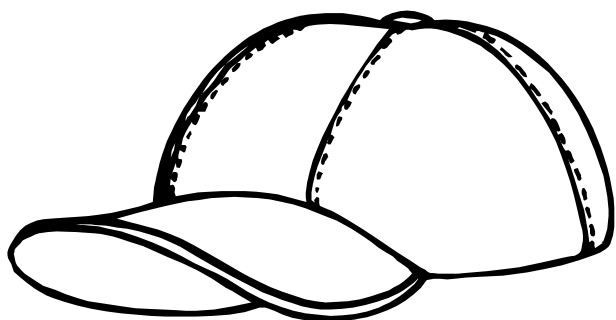
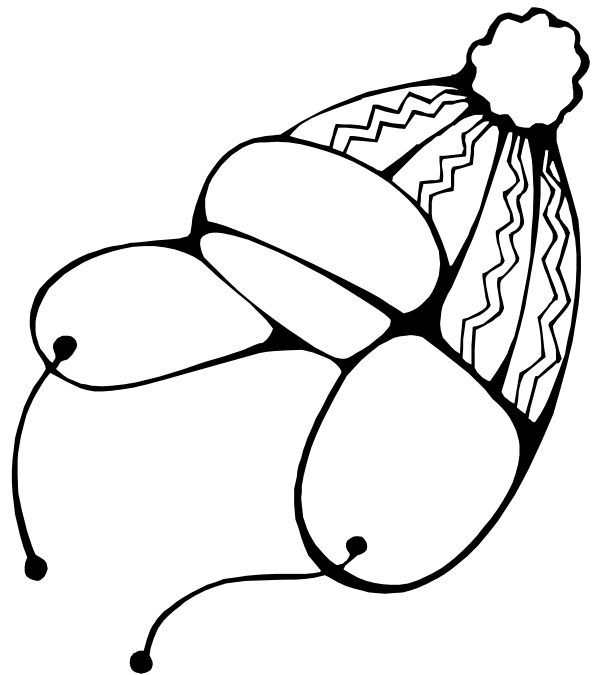
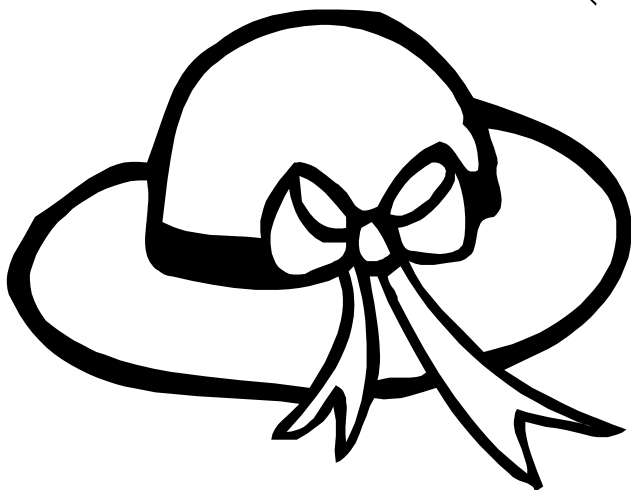
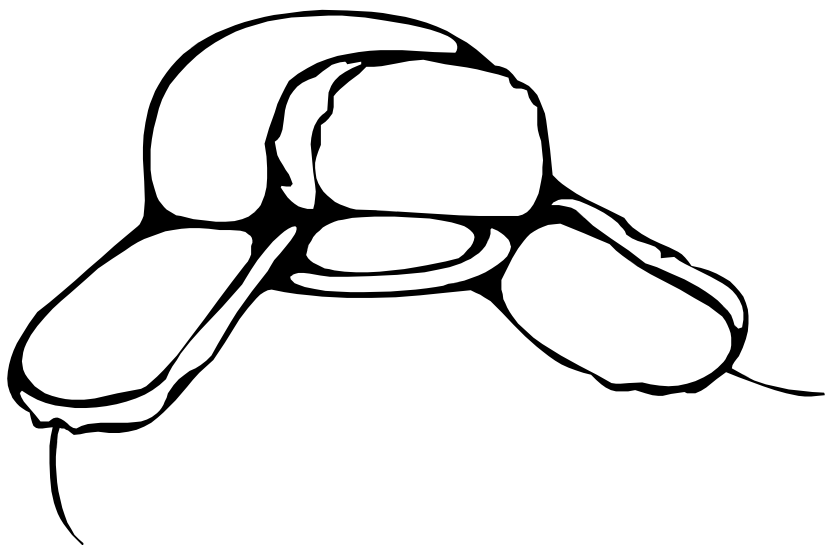
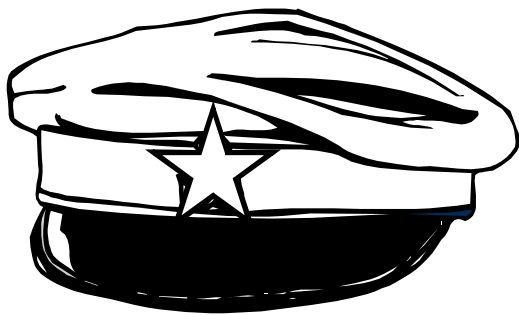
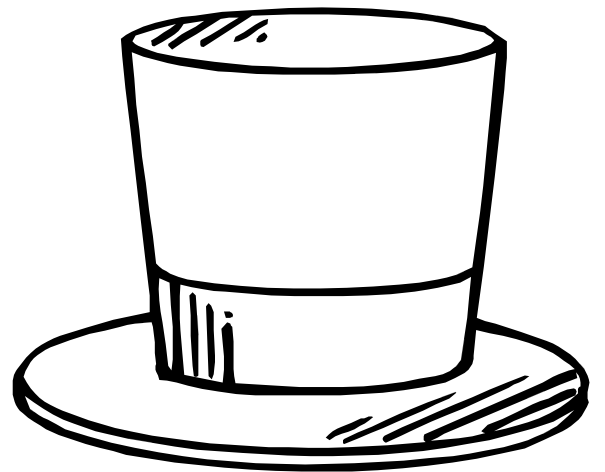
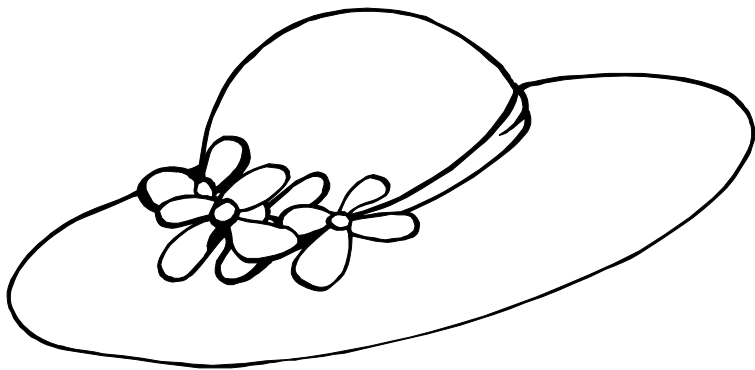

Для чего нужна эта мебель?

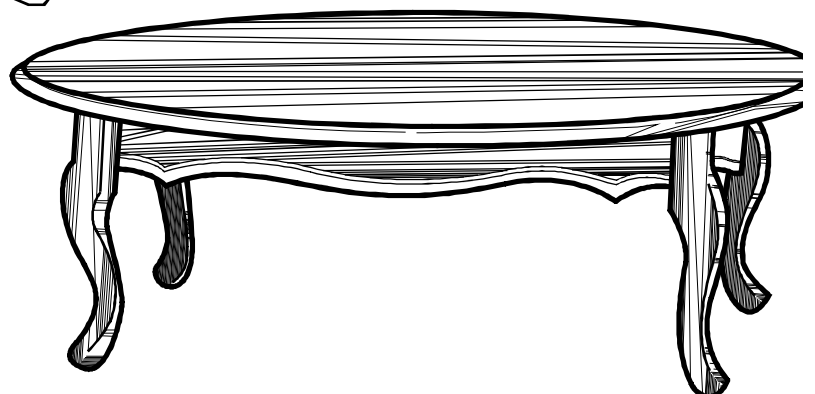
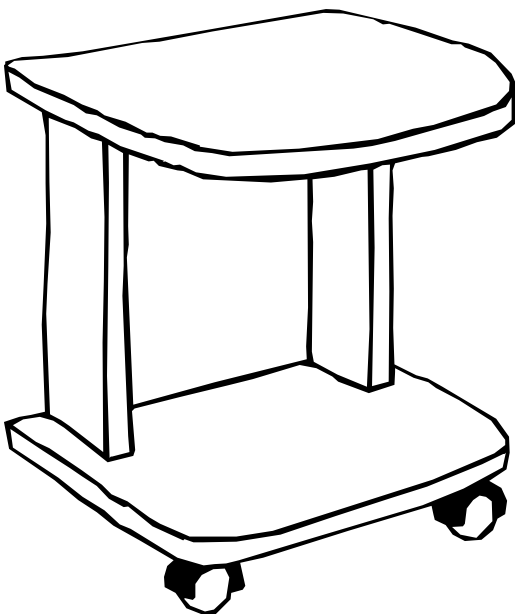
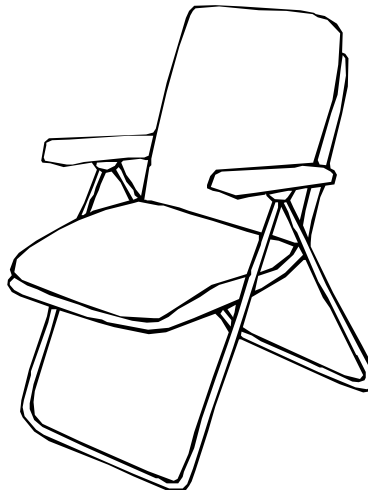
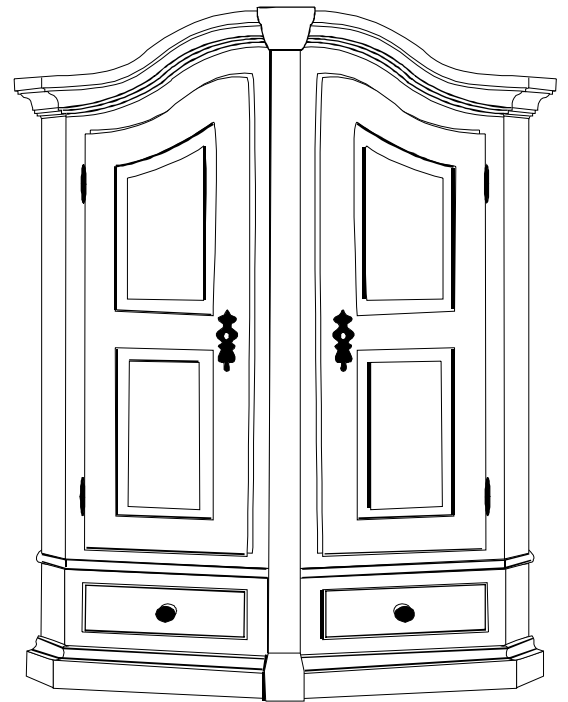
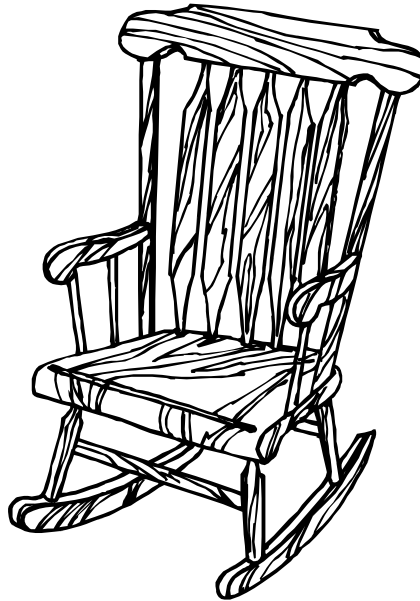
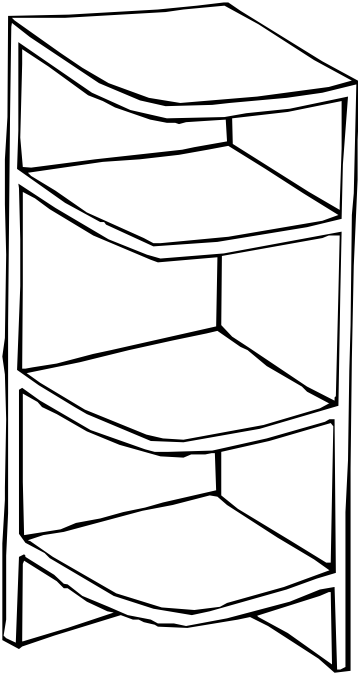
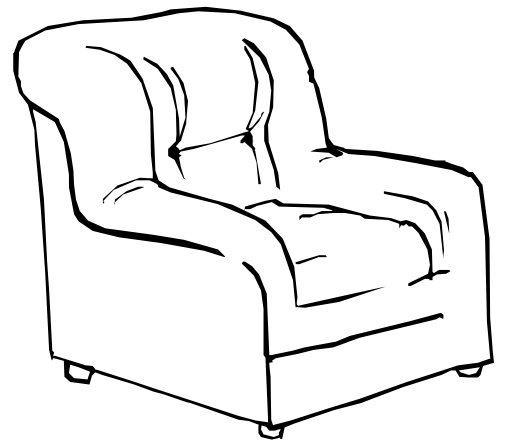
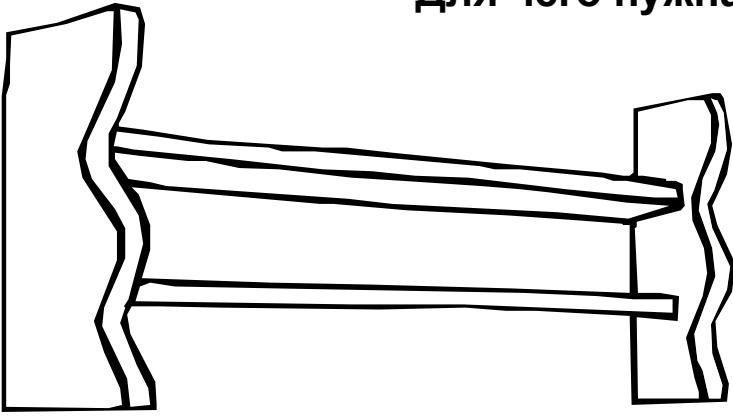

Их чего сделана эта мебель?

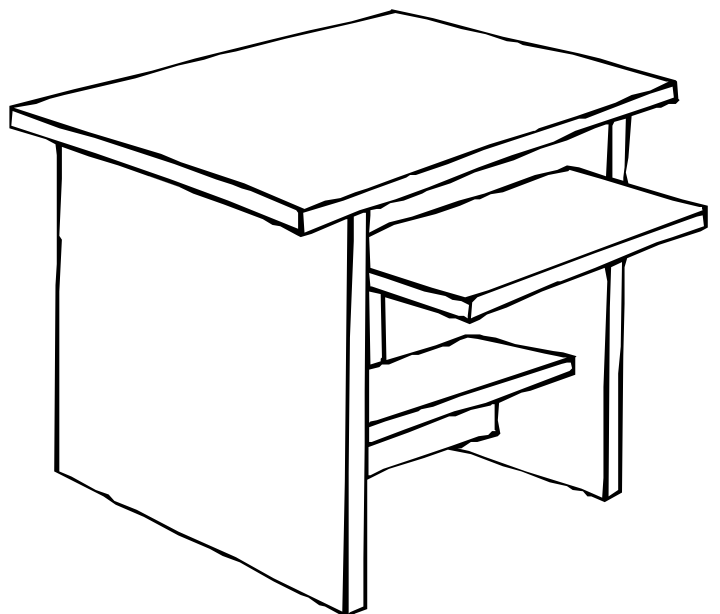
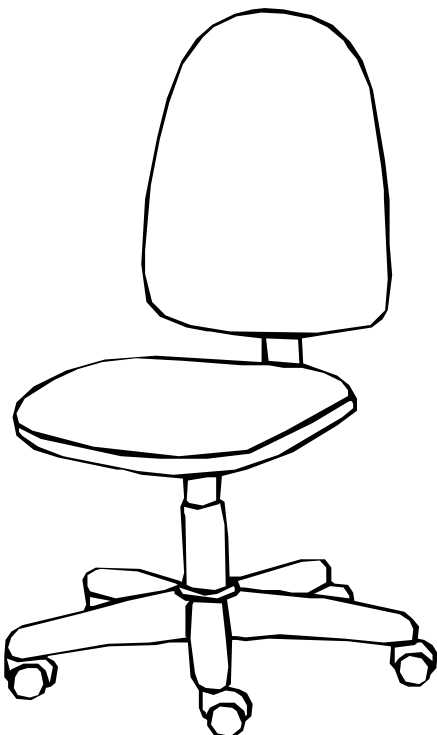
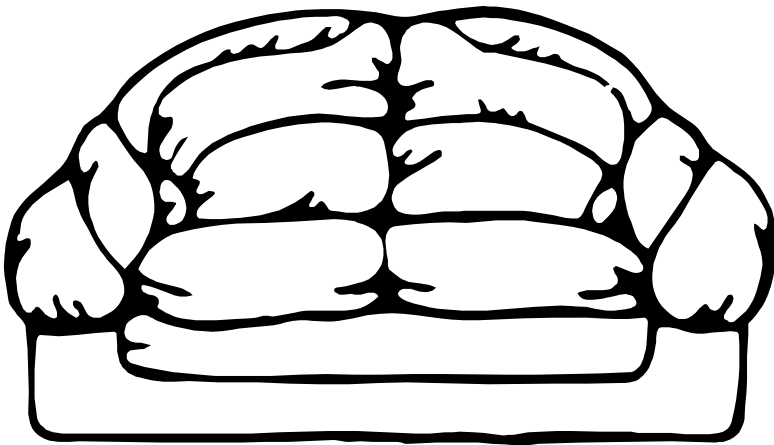
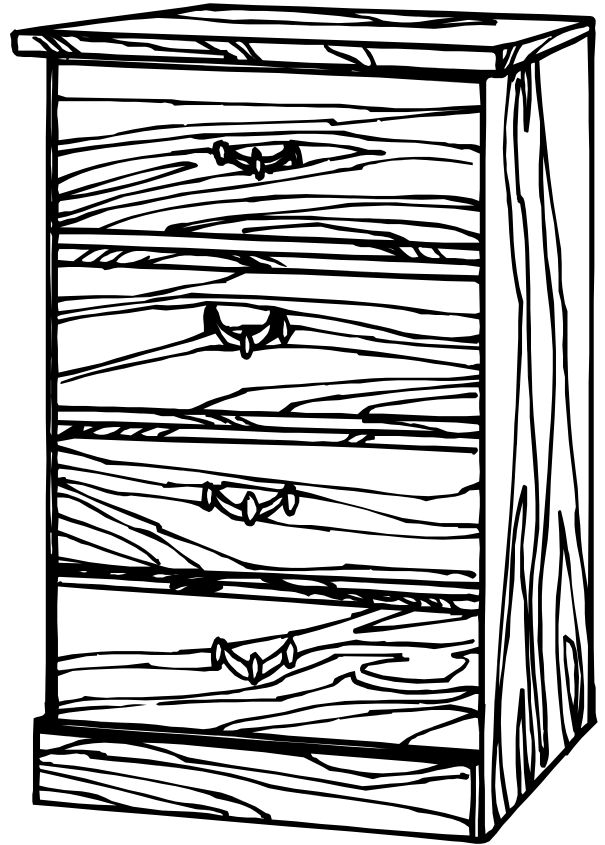
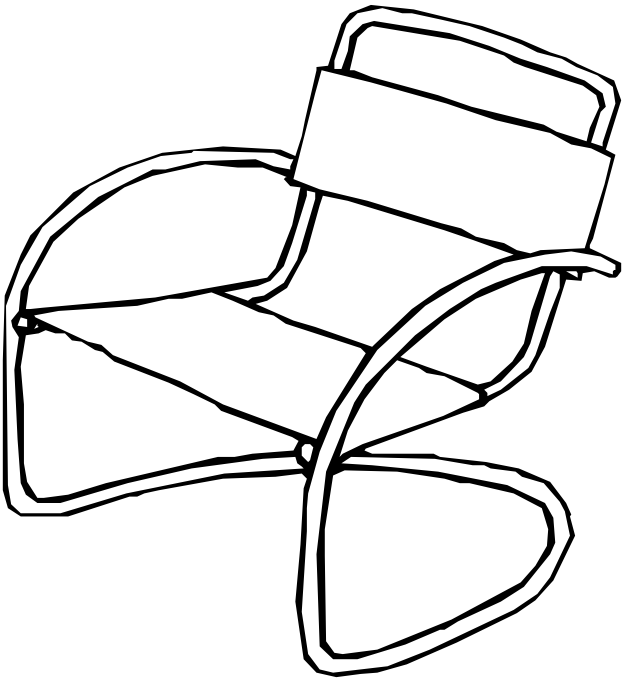

Назови части мебели.

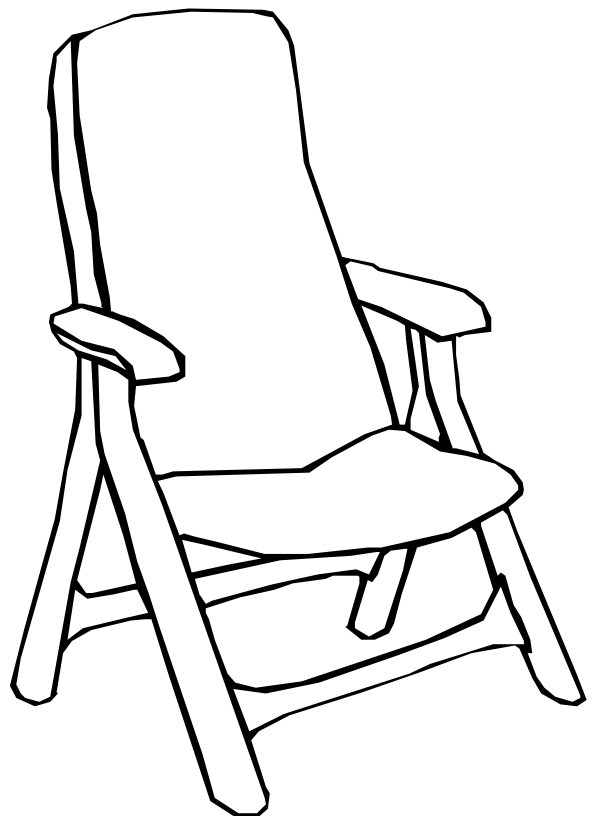
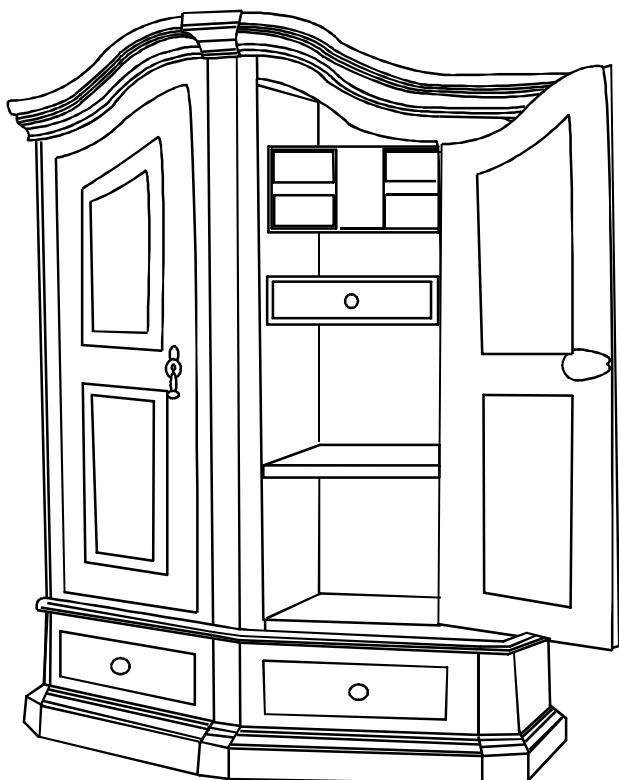
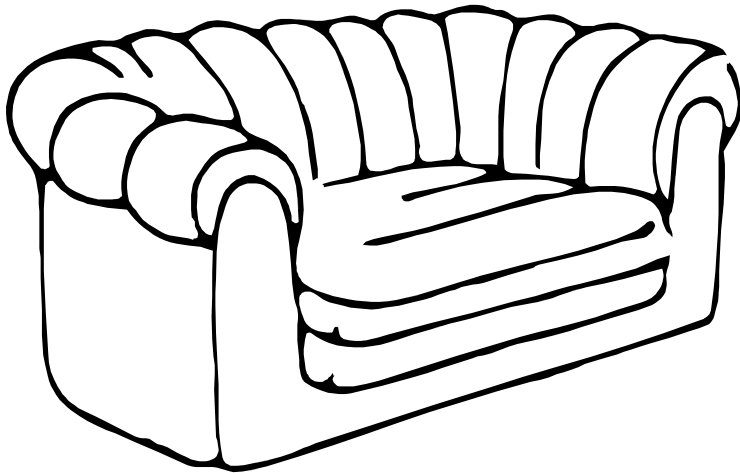
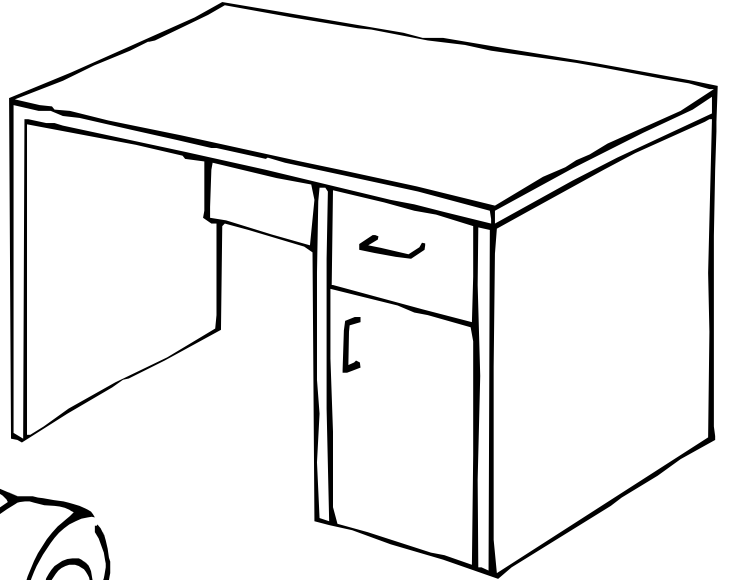
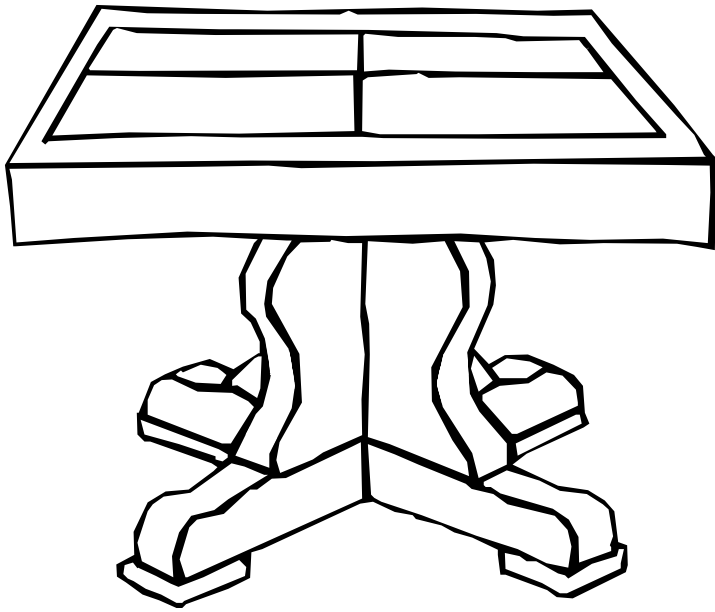

Назови предметы одним словом.

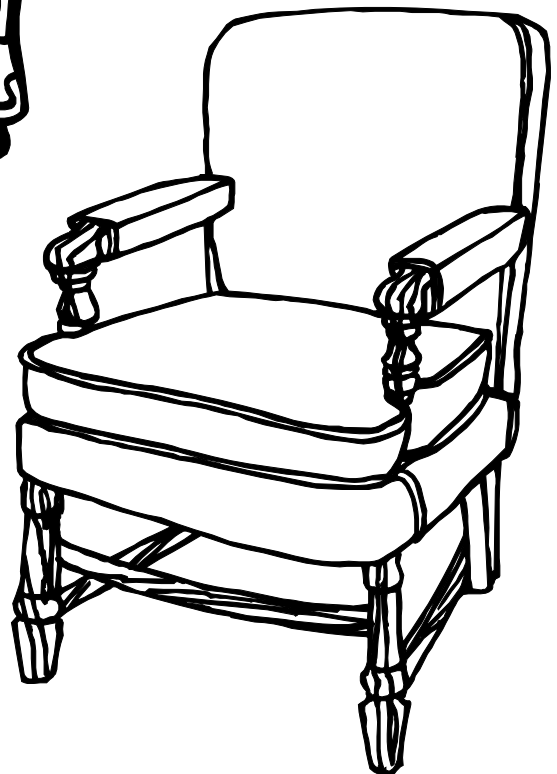
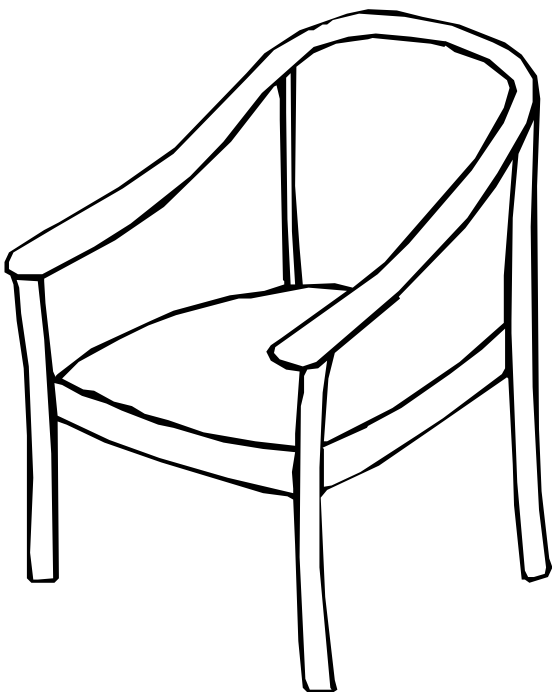
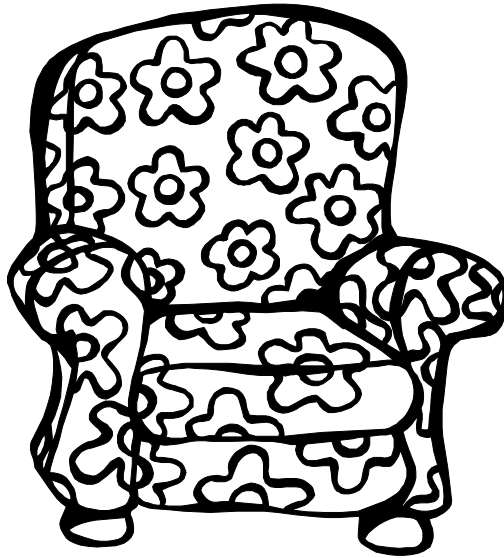
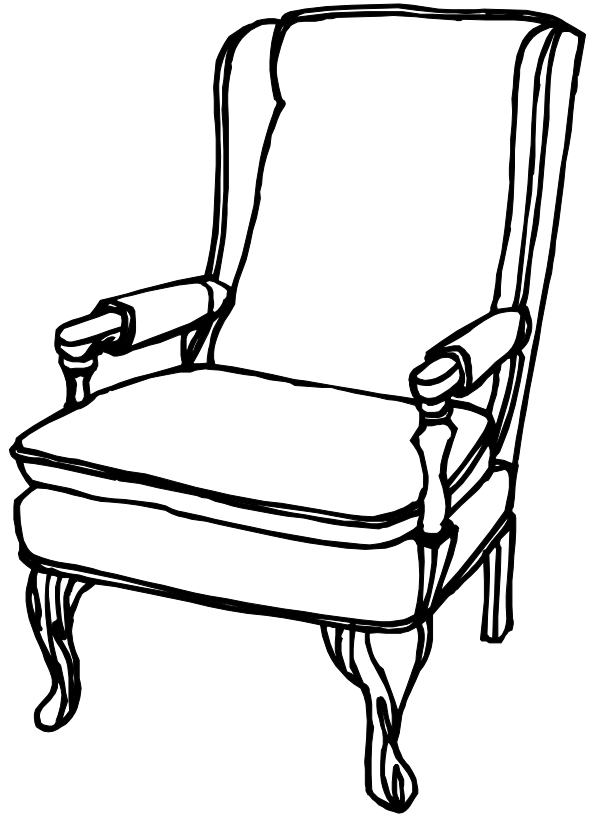
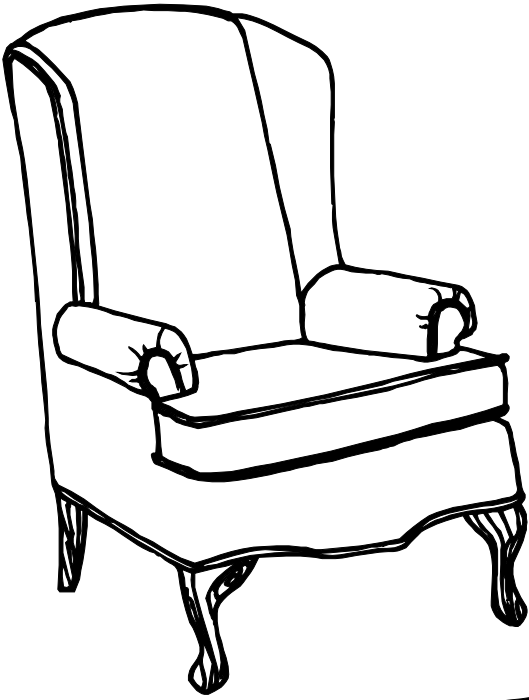

Покажи ударные, клавишные, духовые, струнные инструменты.

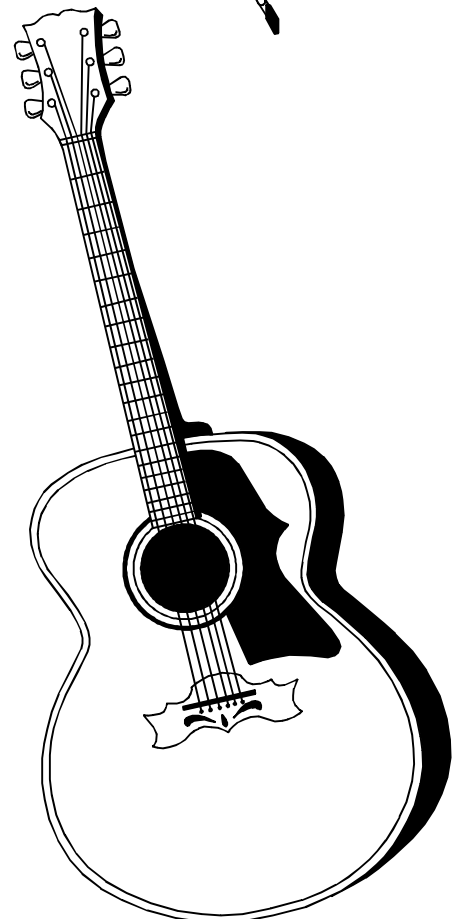
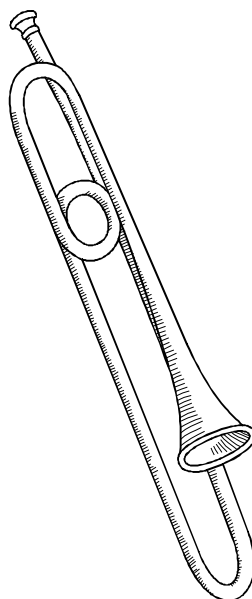
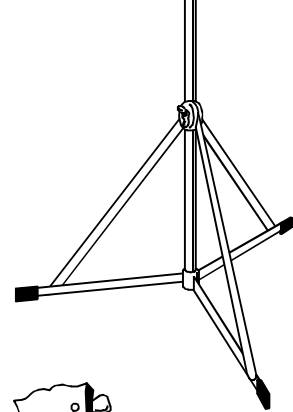
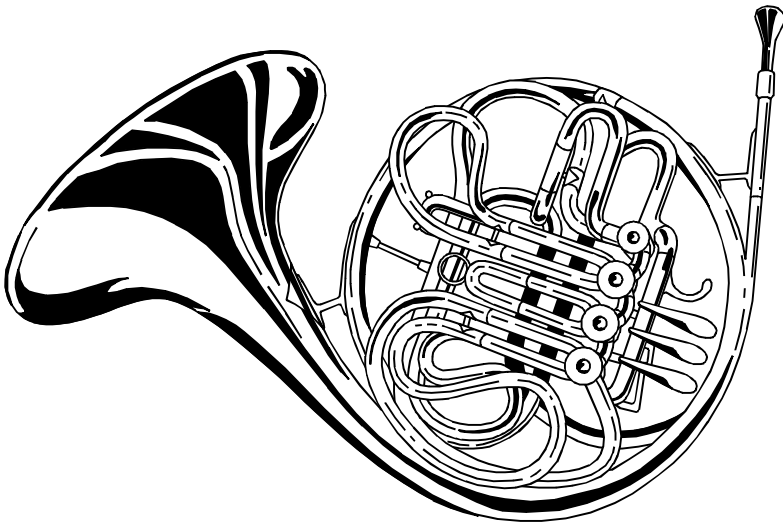
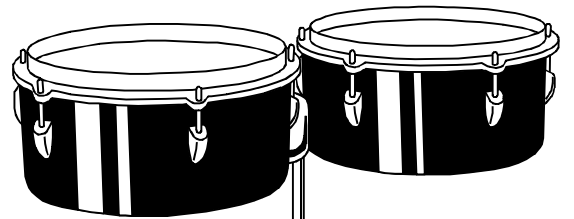
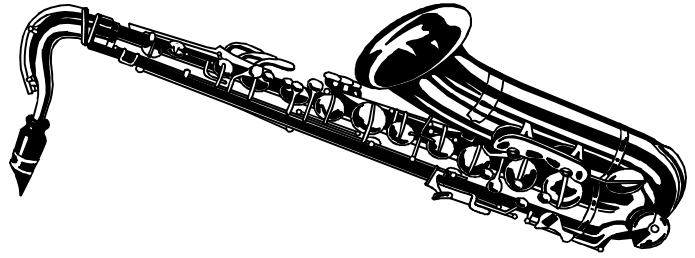
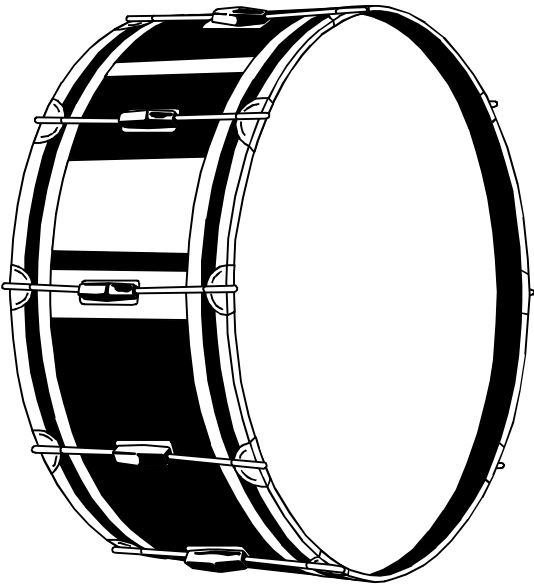

Из чего состоят эти музыкальные инструменты?

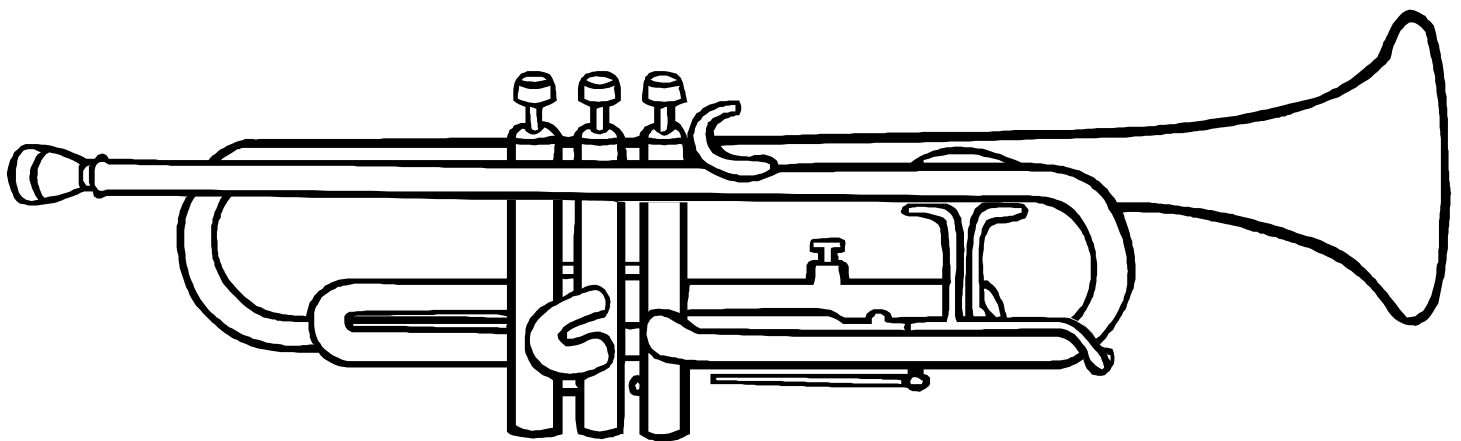
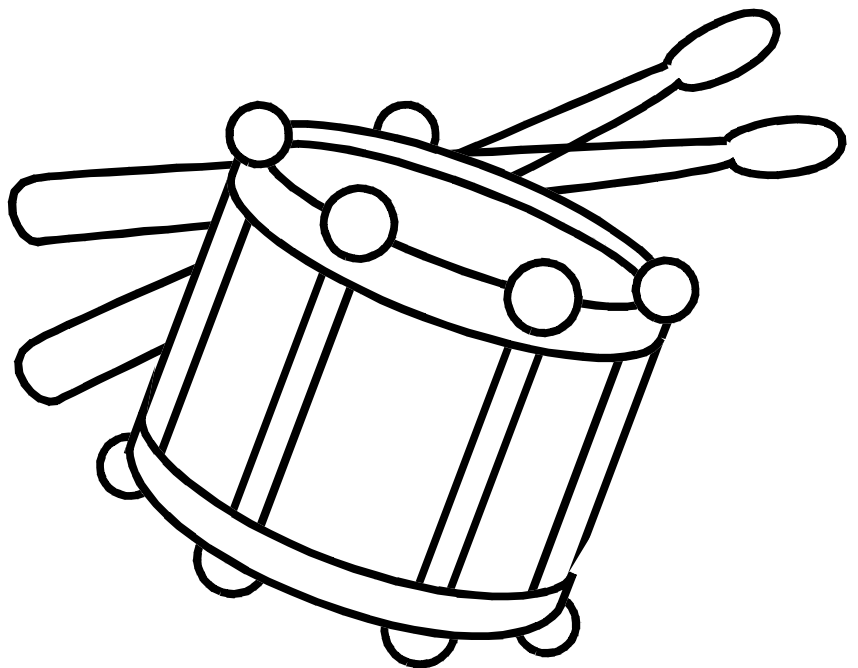
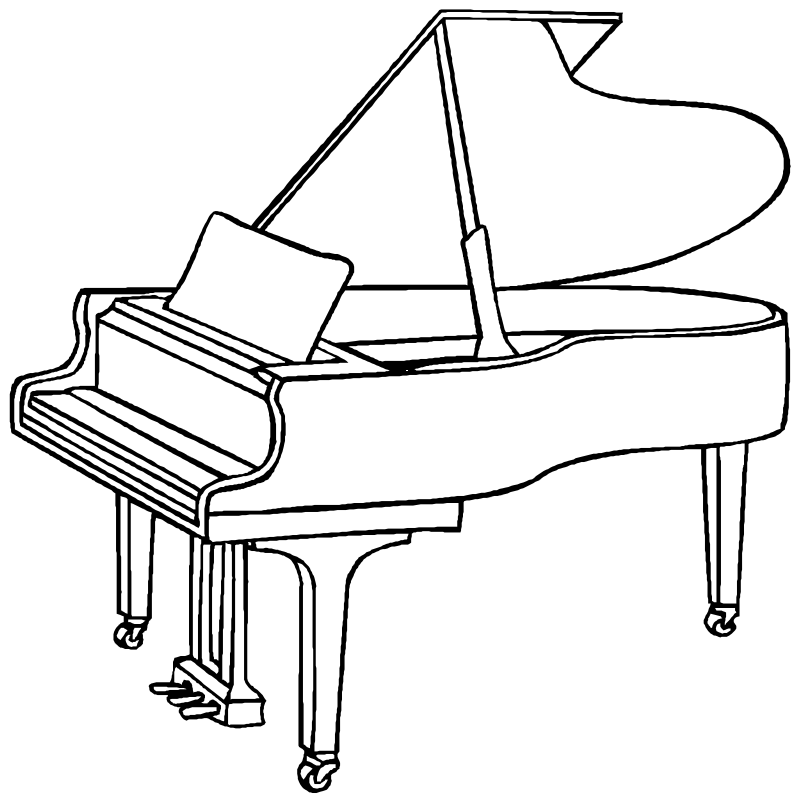
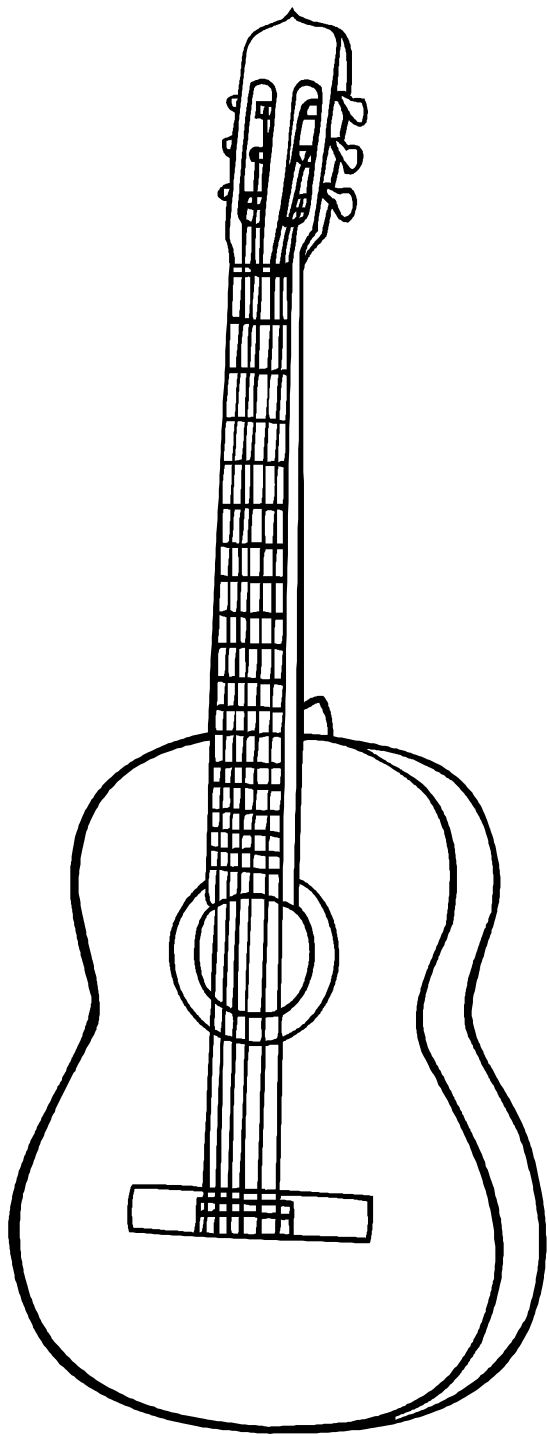

Как звучат эти музыкальные инструменты?

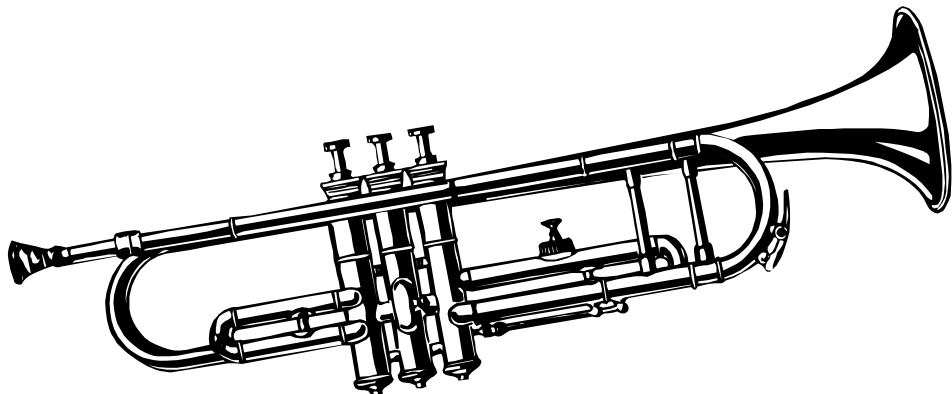
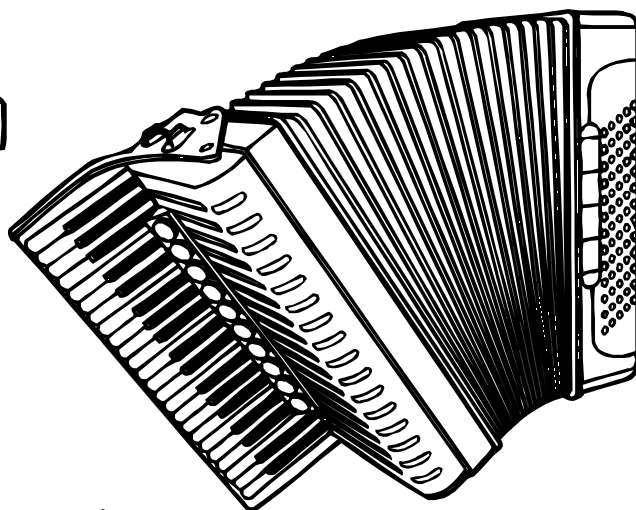
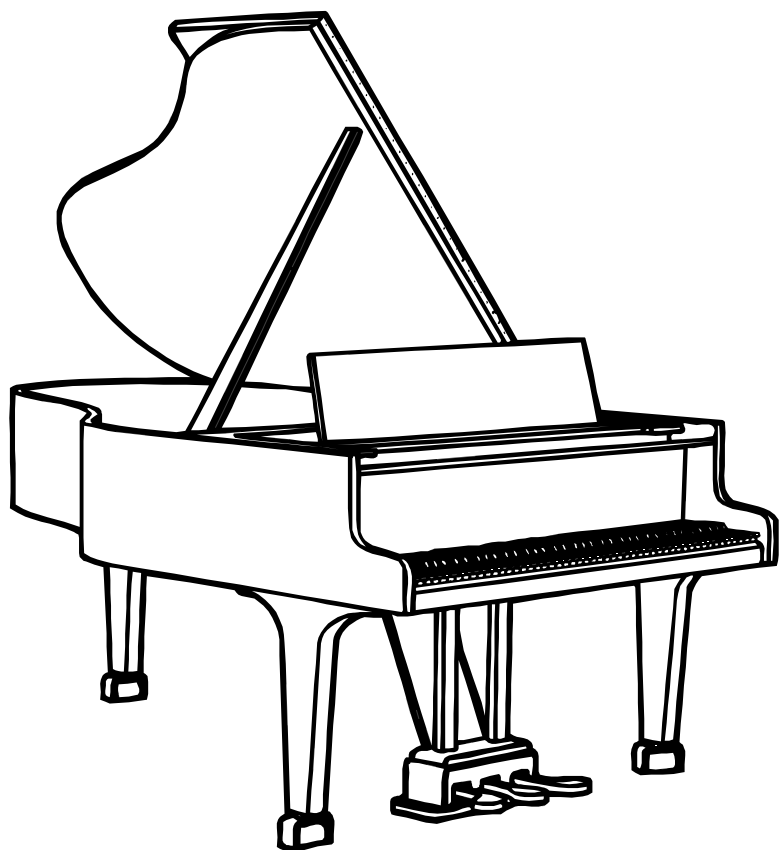
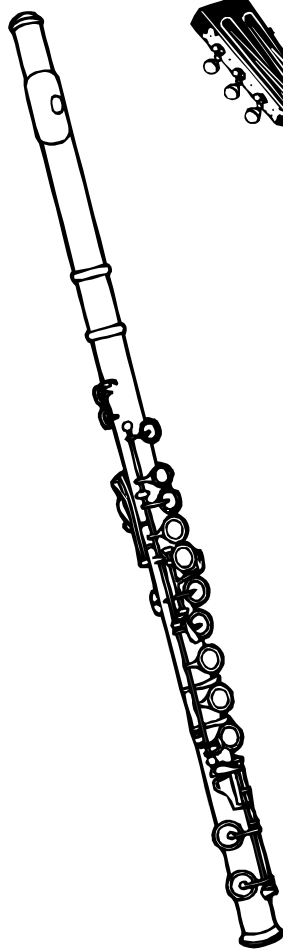
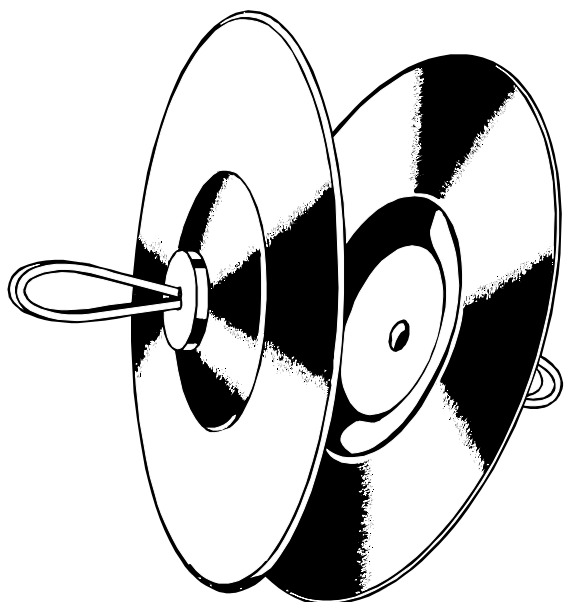

Какие из этих бытовых приборов наиболее необходимы в доме?

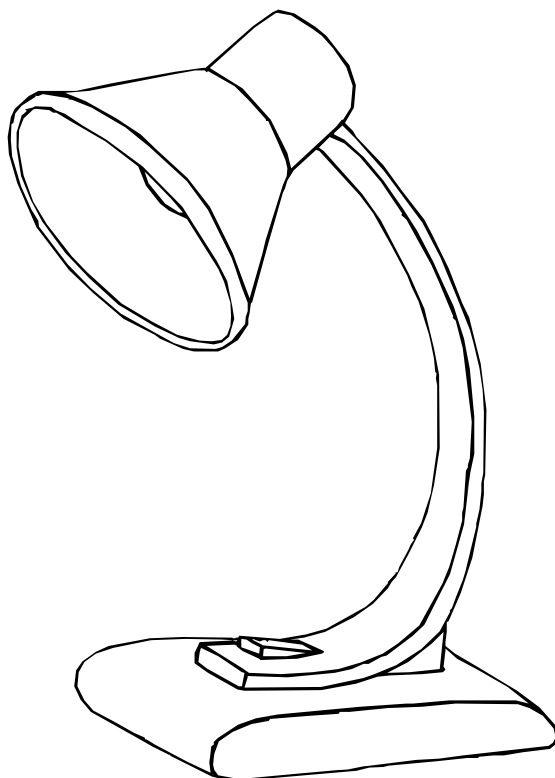
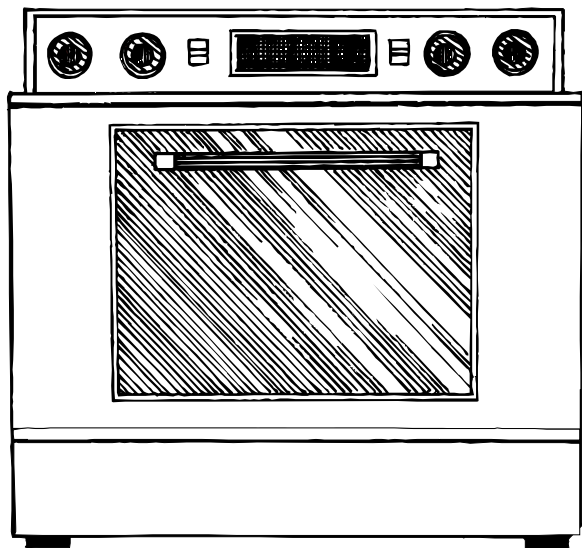
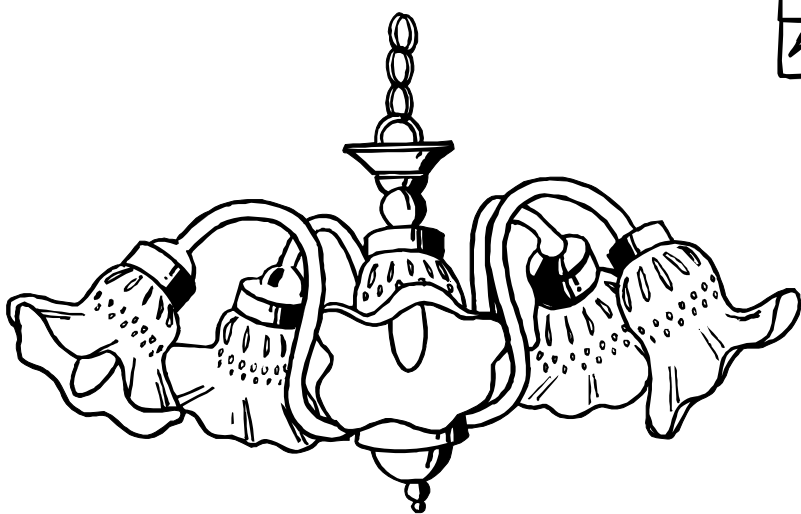
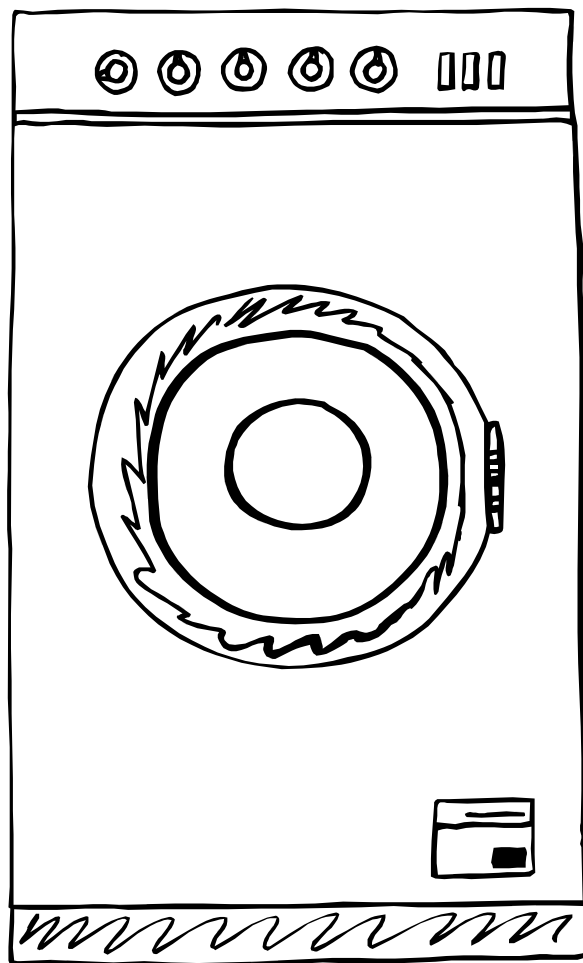
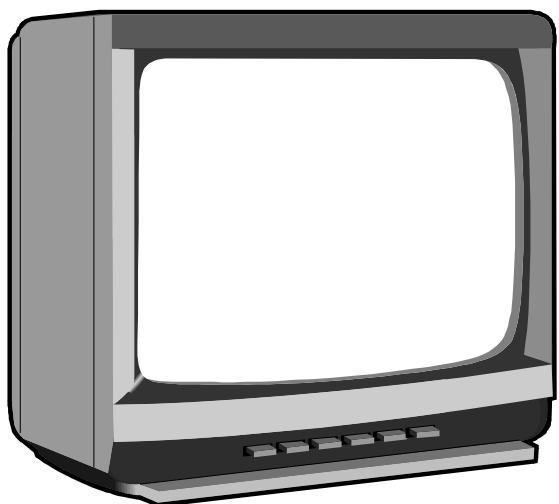

Какие приборы есть у тебя дома?

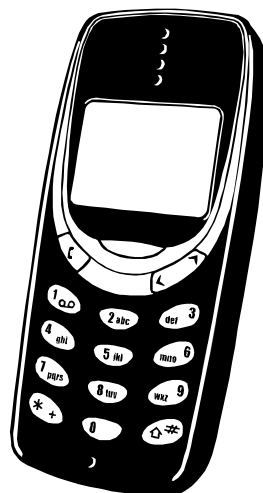
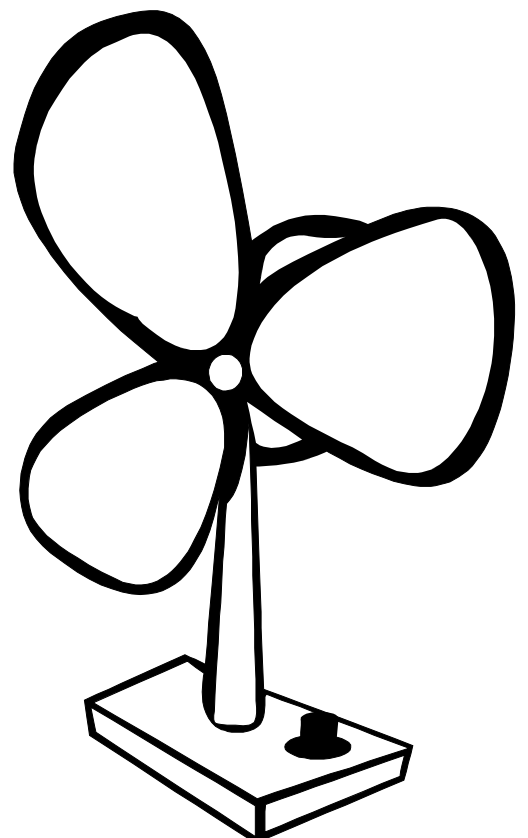
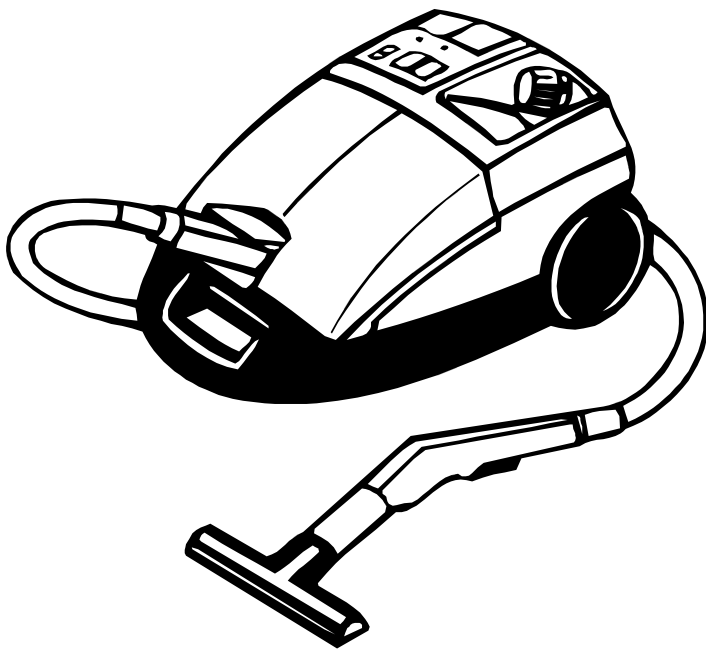

Что делают при помощи этих бытовых приборов?

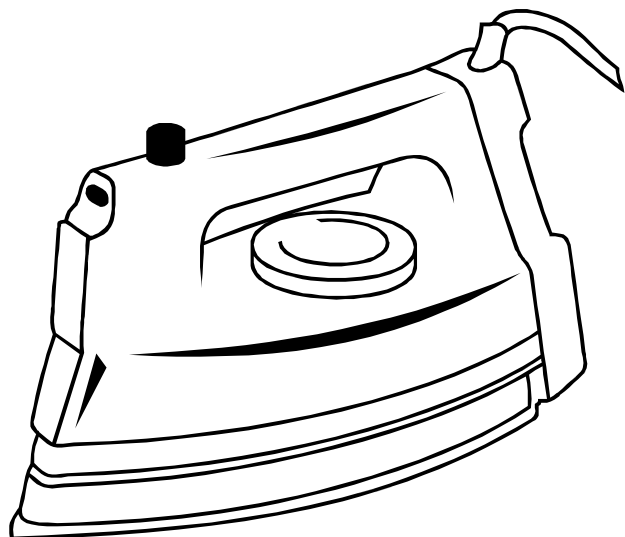
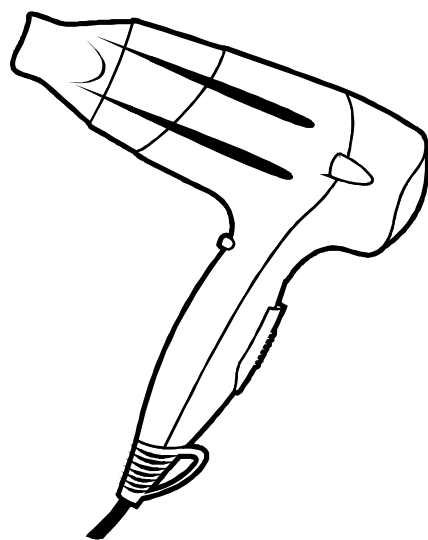
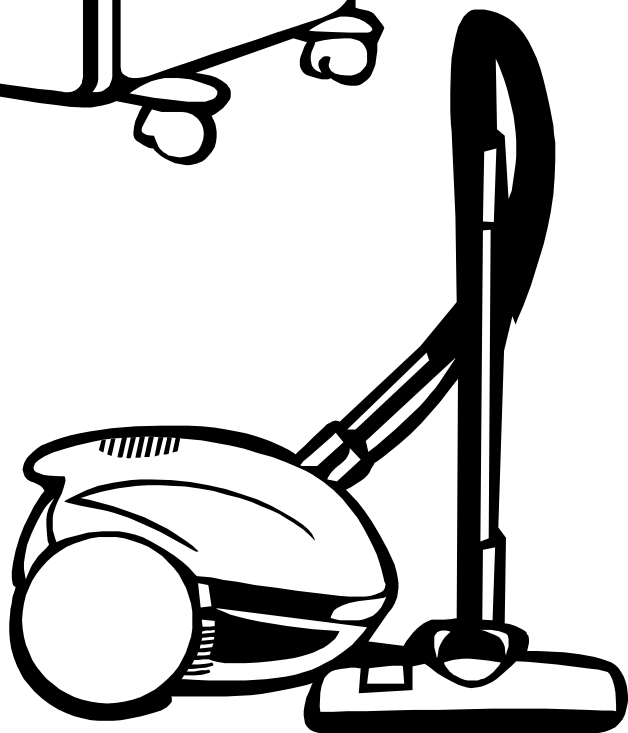
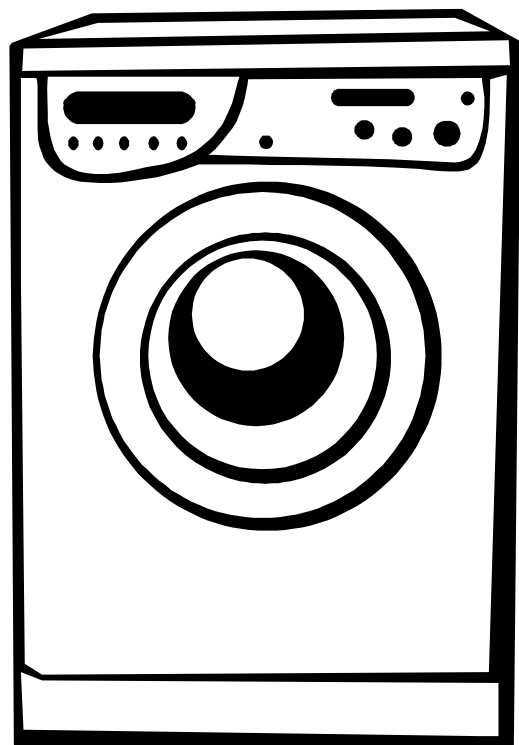
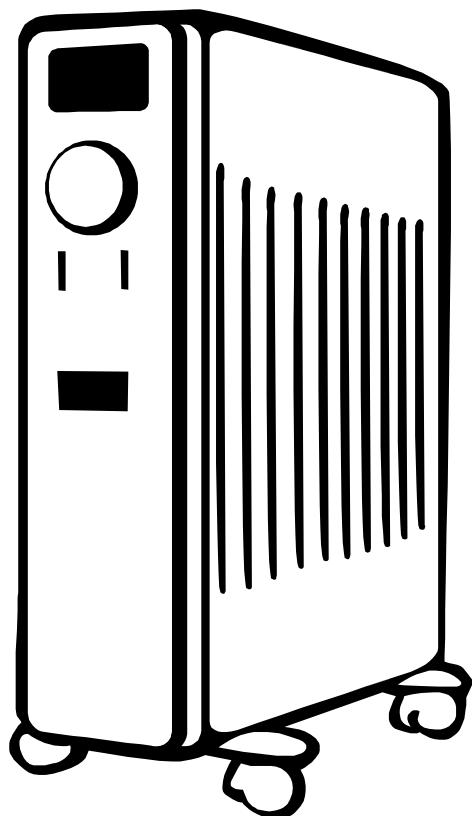

Как раньше люди заменяли эти приборы?

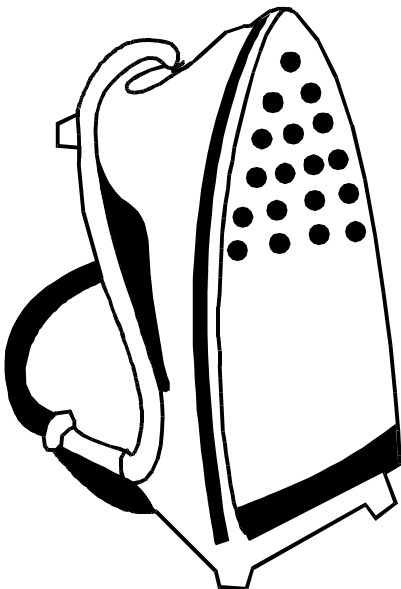
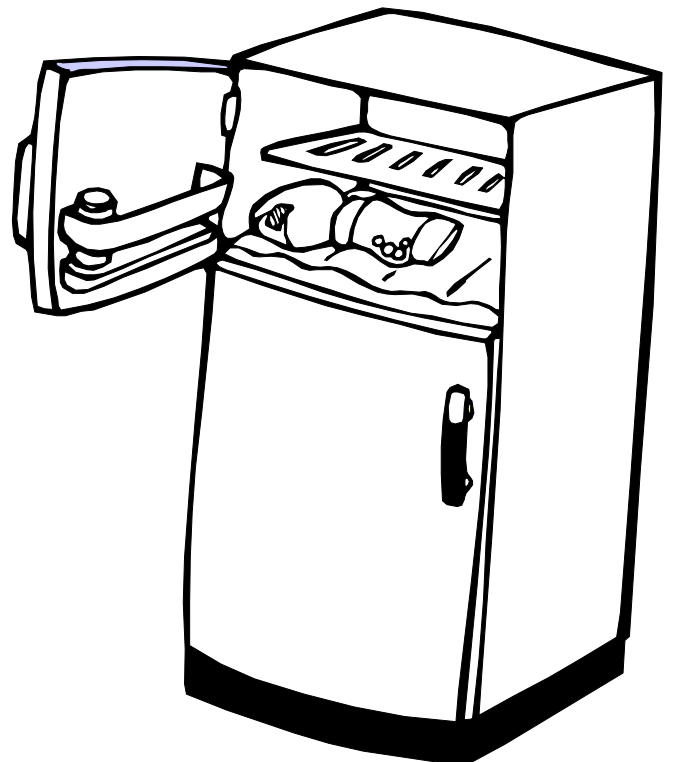
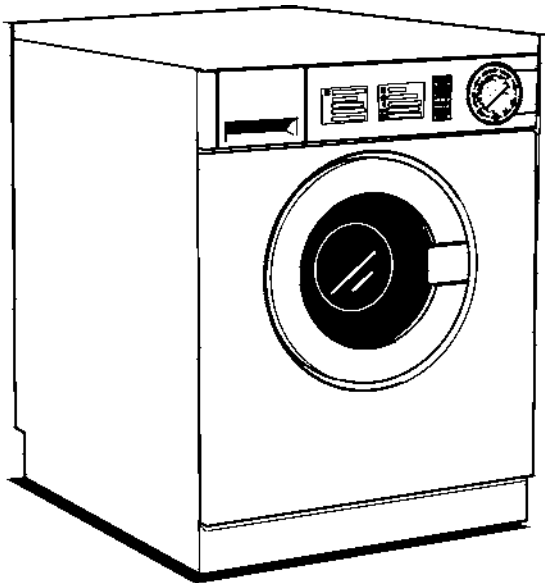
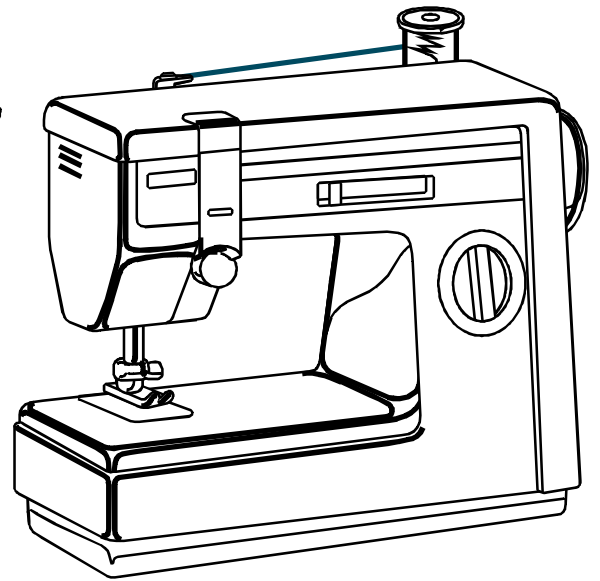
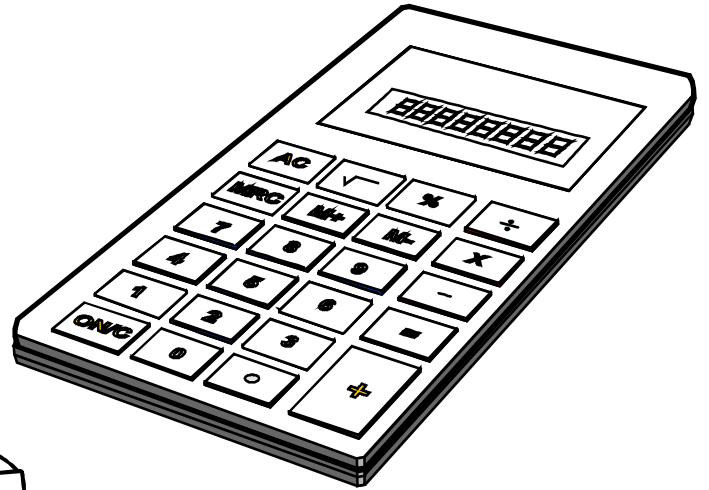
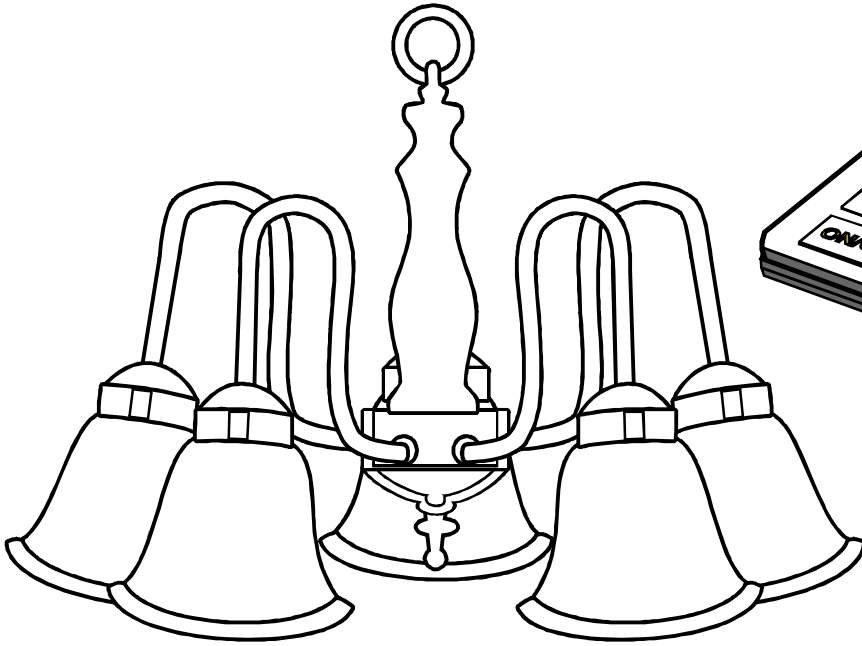

Ответь на вопрос и нарисуй ответ?

Я разговариваю с мамой по...

Продукты хранятся в...

Я чищу ковёр...

Мама готовит пищу на...

Вещи стирают в...

Вещи гладят...

Мы слушаем музыку по...

Я смотрю сказку по...

Раскрась игрушки как тебе хочется.

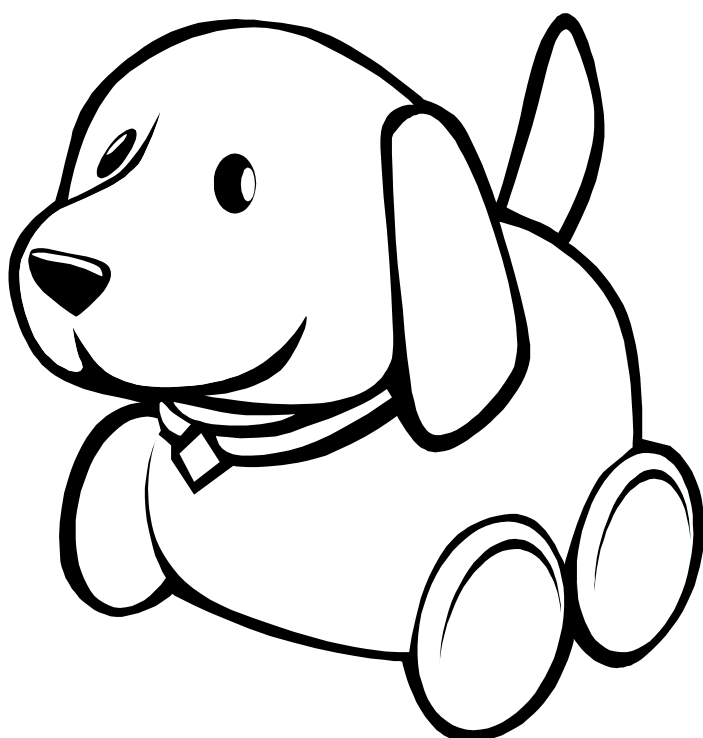
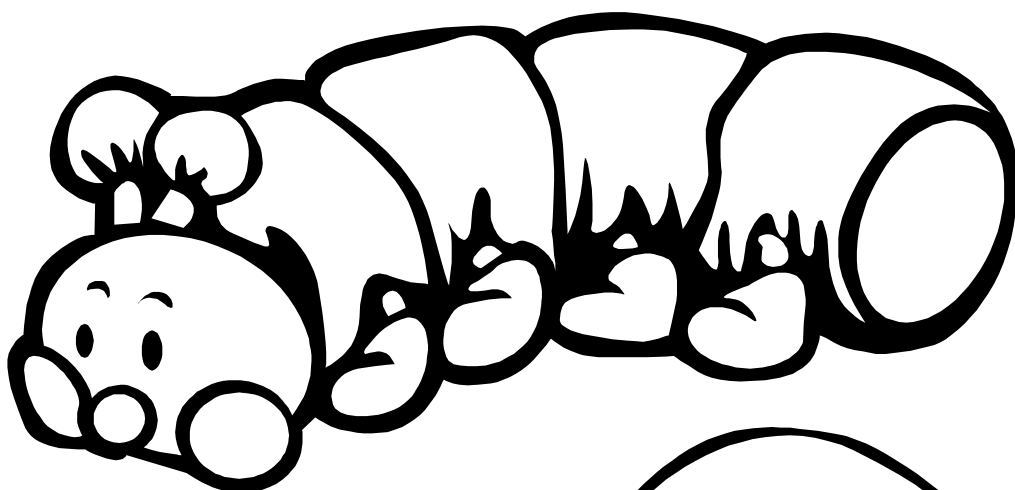
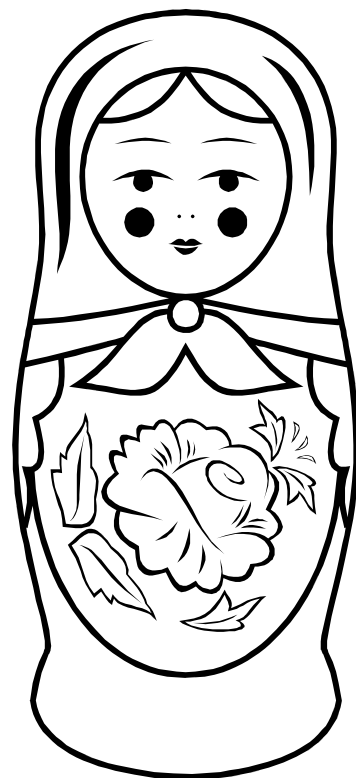
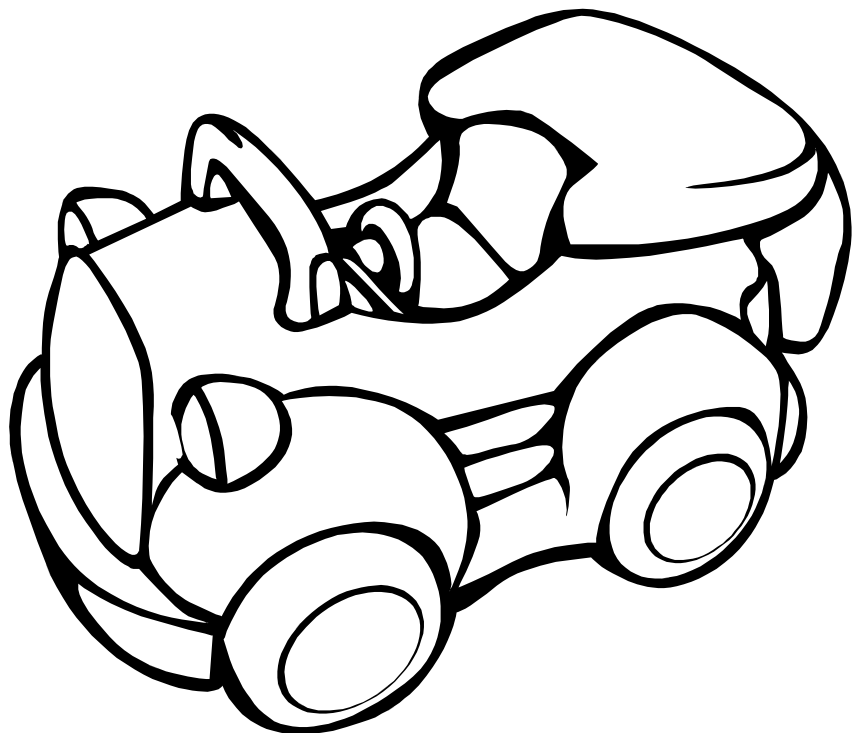

В какие игры можно играть с этими игрушками?

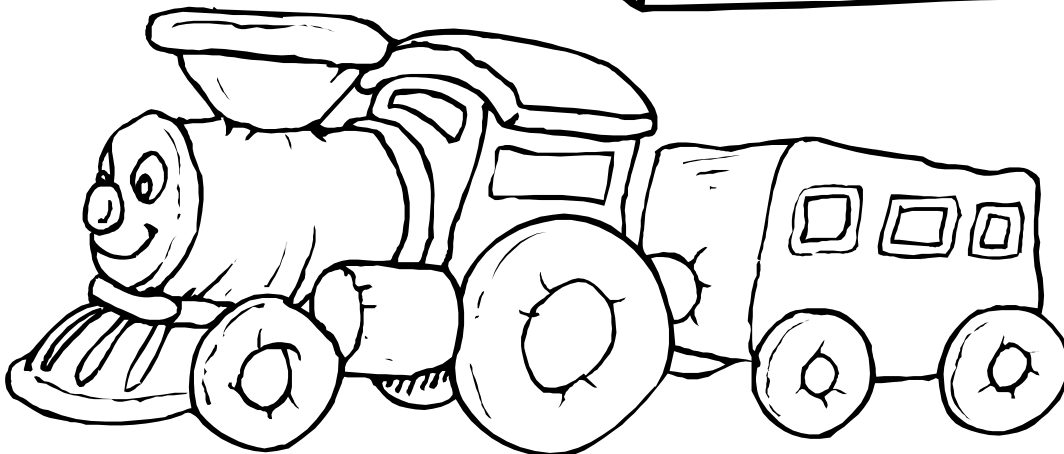
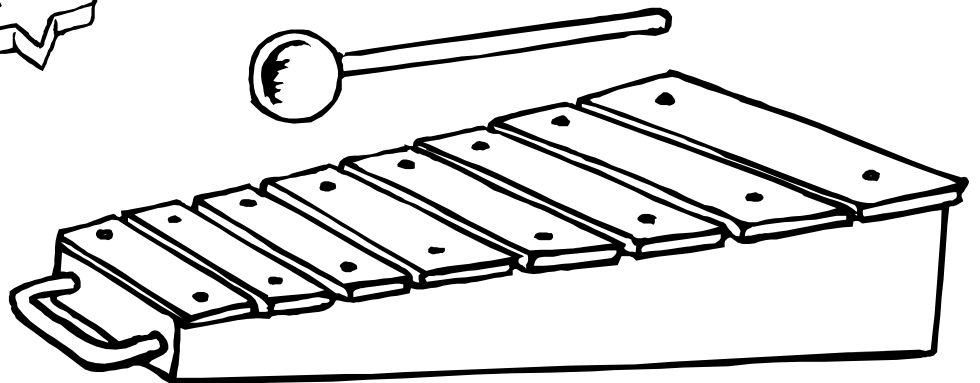
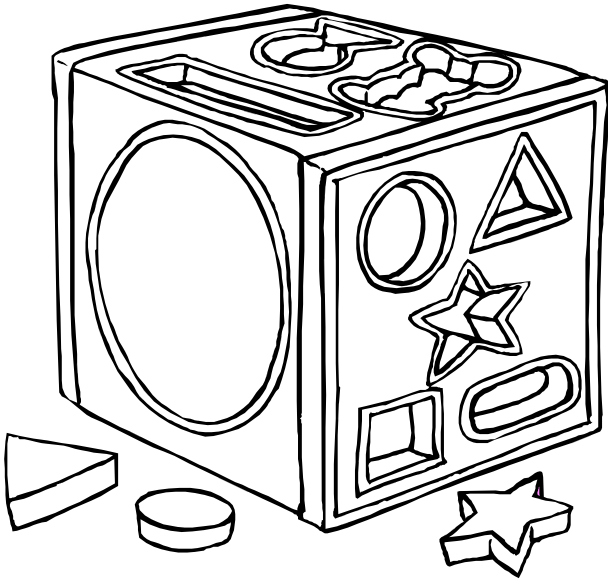
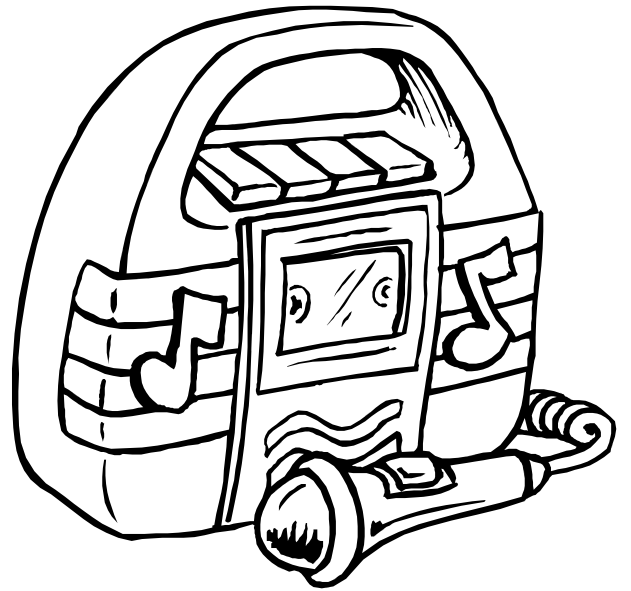
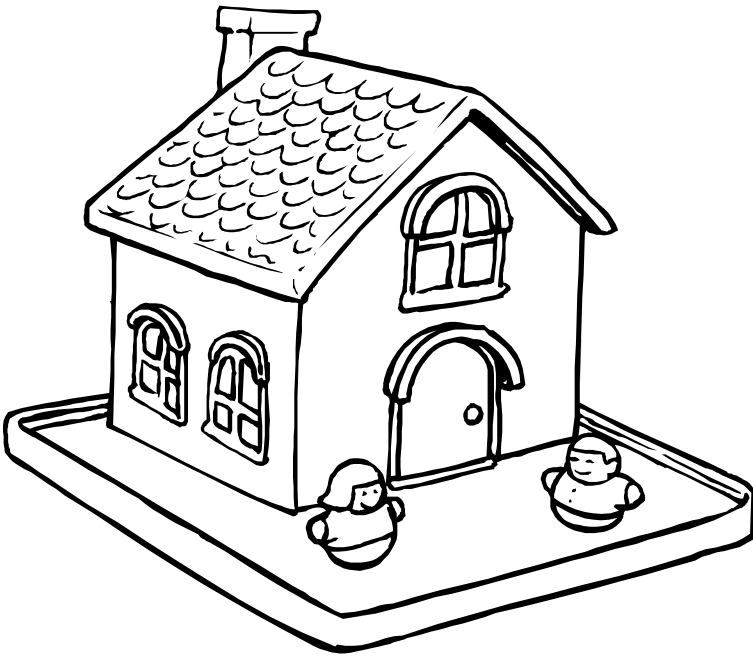

Раскрась игрушки и расскажи как надо обращаться и хранить их.

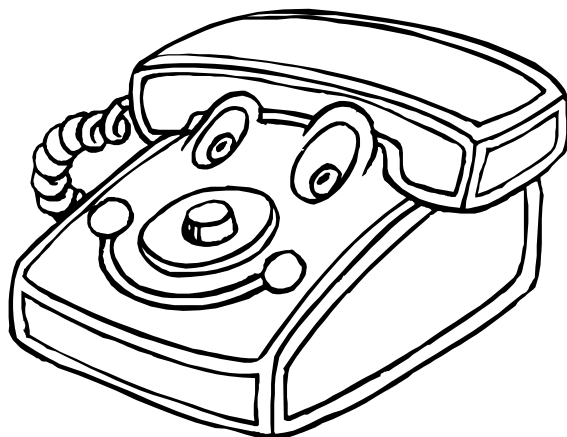
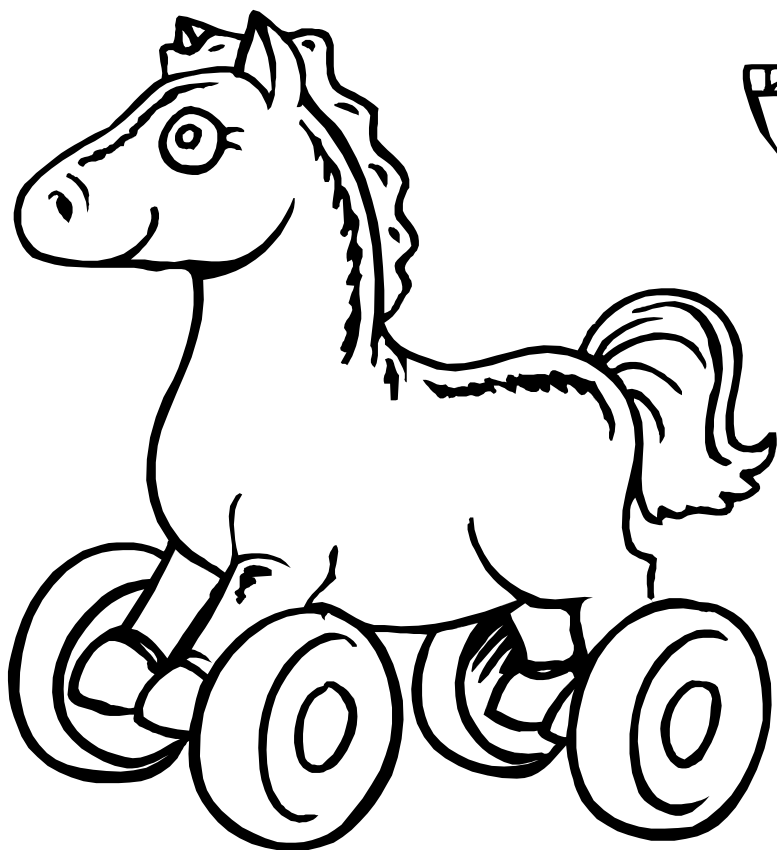
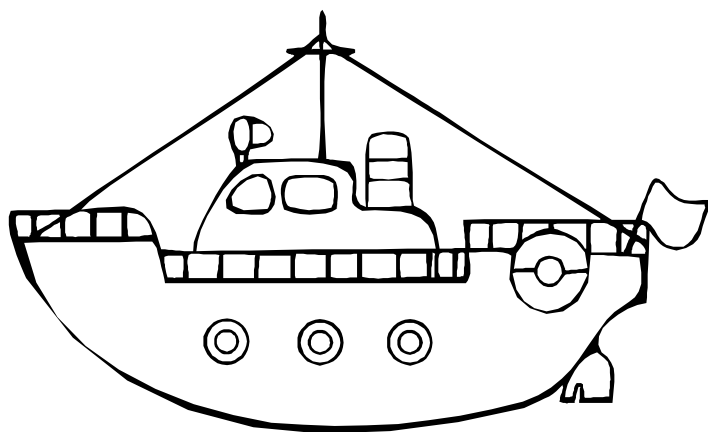
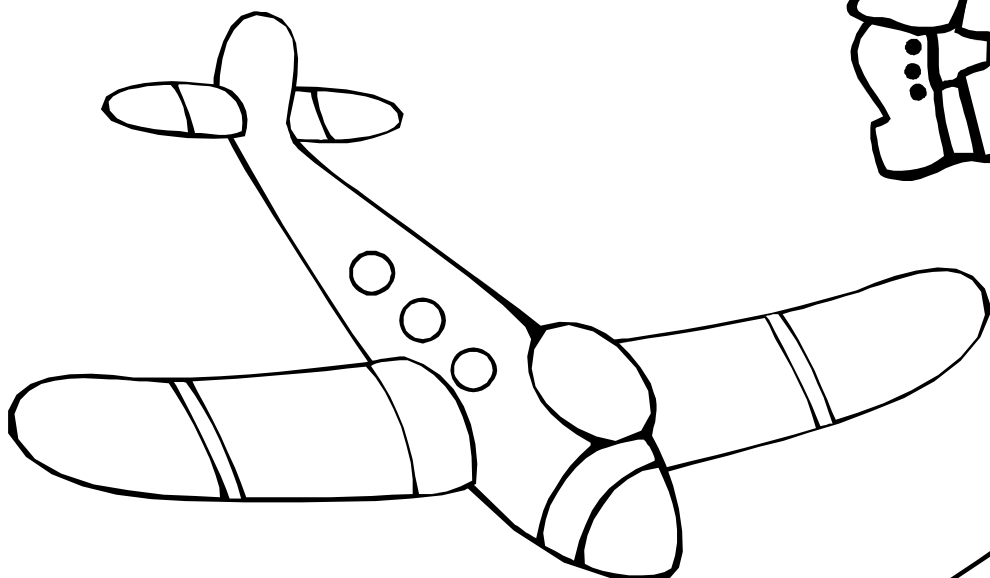
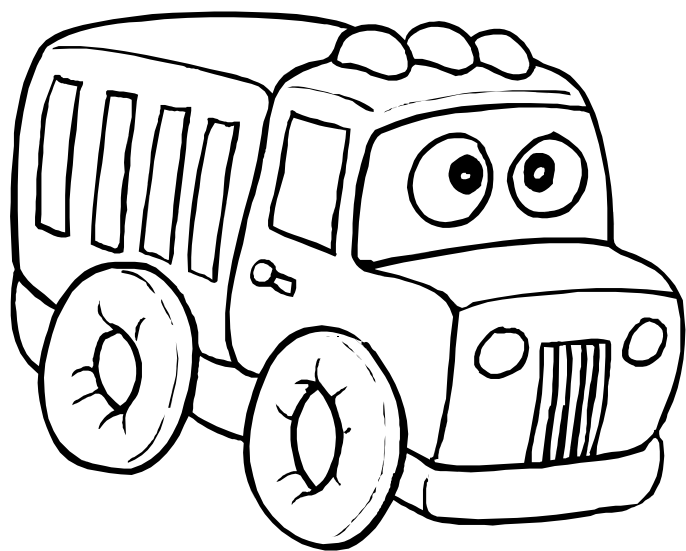

С каким игрушками играют девочки, а с какими мальчики?

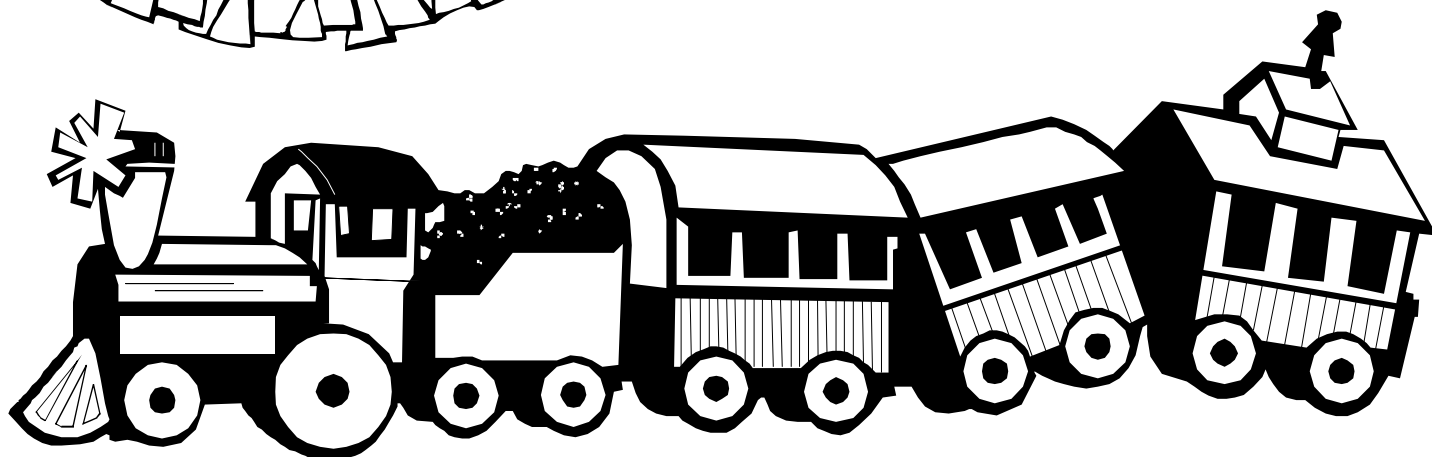
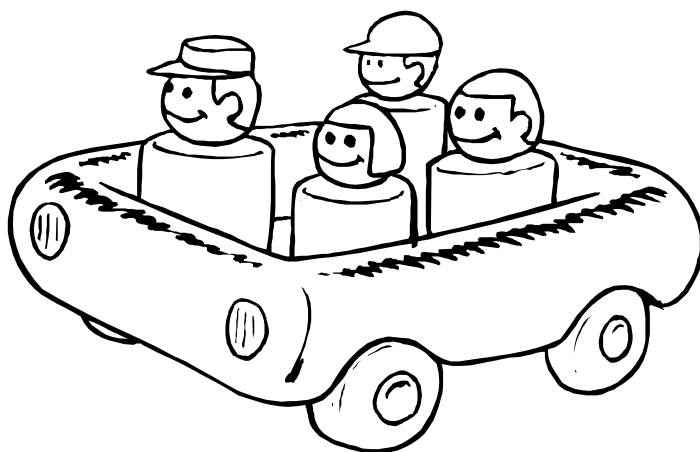
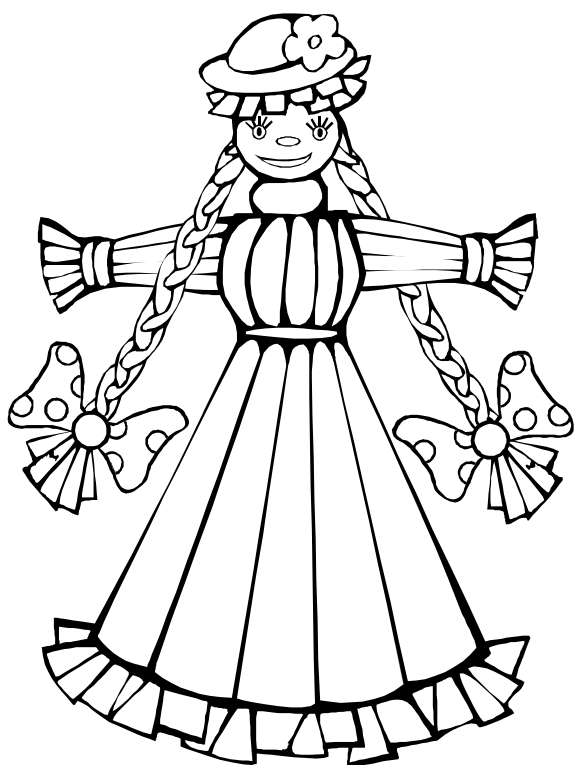
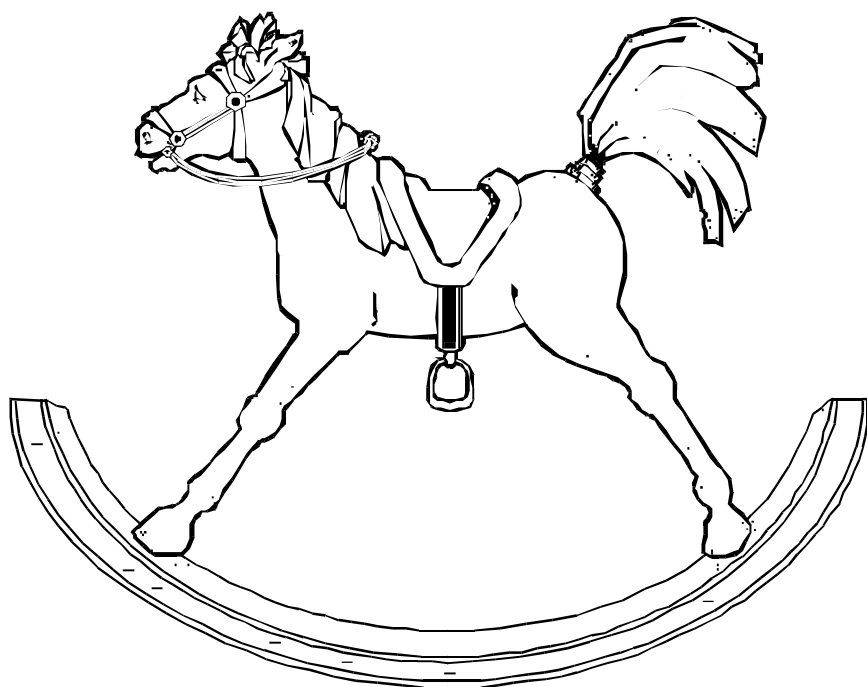

Из чего сделаны эти игрушки?

